



 **LABORATORY**
ESD dot scientific inc.
PRODUCTS SALES
LabMart® Distribution Companies

Cold Storage Solutions





Table of Contents

Cryogenic Freezers

MVE Biological Solutions 3-19

Temperature Chart and Product Selector Guide 3

Long Term Dry Self-sustaining Cryogenic Freezer

MVE Fusion® Series 4-5

Vapor Phase Cryogenic Freezers

MVE HEco™ Series Freezers with Touch Screen 6

MVE High Efficiency -190°C Series with TEC 3000 Controller 7

MVE Vario™ Series with Touch Screen 8

Liquid Phase Cryogenic Freezers

MVE Series with TEC 3000 9

Cryogenic Freezers For In Vitro Fertilization

MVE Stock Series - 2T Models with TEC 3000 (Vapor Phase) 10

MVE Stock Series with TEC 3000 (Liquid Phase) 11

CBS Cryogenic Solutions

 20-25

Isothermal Cryogenic Dry-Vapor Freezers

V-Series Full Lip Opening and Carousel Vapor Models 20-21

Cryogenic Liquid Phase Freezers - Standard Series

 22

Controlled Rate Freezers (CRF)

Model 2101 23

Model IntelliRate i67C 24

Dewars

MVE - SC (Standard Capacity) Series - Compact Aluminum 12

MVE - XC (Extra Capacity) Series - Aluminum 13

MVE CryoSystem Series - Medium Vial Storage 14

MVE Research Dewars - Small, Temporary Storage 15

MVE Lab Series Liquid Dewars 16

MVE Doble Series - Qwick Charge Technology 17

MVE Vapor Shipper Series - Qwik Charge Technology 18

MVE CryoCube™ & BL-7 19

MVE Blood Bag Shippers 19

CBS Series 2001, 4001 and 6001 Value Added Cryosystems 25

Cryogenic Racks, Frames and Canisters

 26-27

Cryogenic Safety

Gloves, Face and Eye Protection, Aprons 28

Cryogenic Accessories

MVE Cryo Cart / Workbench 11

MVE Cool Reach Retrieval Tool 40" 11, 29

Sample Retrieval Devices 29

Measuring Sticks 29

Cryomarkers 29

Cryogenic Vials

Barcoded 1D 29

Tricode Barcoded Pre-set 1D & 2D 30-31

Tricode SBS Format Combo External Thread 31

Cryogenic Vials and Cap Inserts, Sterile 32-33

Cryogenic Freezer and Storage Boxes

 34-36

Refrigerators and Freezers

Energy Star Rebates

 37

Combination Freezers/Refrigerators

 38-40

Refrigerators

Freestanding Under Counter Lab Refrigerators 40-41

Built-in Under Counter Lab Refrigerators 41-42

Refrigerators - Upright

 43

Compact Lab Refrigerators 43

Glass Door Lab Refrigerators 43-44

Solid Door Lab Refrigerators 44-46

Flammable Storage Lab Refrigerators 46

Hazardous Location Lab Refrigerators 47

Pharmacy/Lab Refrigerators

 47-49

Freezers

Countertop and Under Counter Freezers

 51-53

Biomedical Freezers

 54-55

Upright Freezers

Manual Defrost 55-57

Manual Defrost Freezer Chest 57

Auto Defrost 57-58

Flammable Storage 58

Manual Defrost Hazardous Location 59

Ultra-low Temperature Freezers

Under Counter 59-60

Chest Freezers 61

Upright Freezers 61-65

Energy Saving 65-67

Energy Saving Chest 66

ThermoFisher TSX Universal 68-71

ThermoFisher TSX Universal FDA Class II 71

Accessories

K2 Scientific Vitallog Vital Power Supply (VPS) Battery Backup 49

ABS Refrigerator Baskets 50

Freezer Racks 56, 72

Macro Tubes 73

Cooling Blocks and Dry Baths 74

Temperature Control Equipment 75-76

Other Cool Products Throughout Catalog

Terms and Conditions

How to Order: Specify catalog number, product description, quantity and price.
Freight Claims: Shipments leave our warehouse in good condition. Any cartons showing external damage should be refused, or the damage noted on the Bill of Lading at the time of delivery. Damaged or missing cartons must be reported within 15 days of receipt of merchandise.
Terms: Terms of payment are Net 30 days for established accounts.
Credit Cards: VISA, MasterCard, Discover and American Express as methods of payment.
Shipping: Orders are shipped via UPS Ground or common carrier, unless otherwise requested.
Warranty: The Labmart Distribution Companies are distributors of these products and in no way offer a warranty independent of the manufacturer's warranty. Nothing

in our product offering is provided an independent warranty by The Labmart Distribution Companies.
Returns: Returns will not be accepted without prior authorization from The Labmart Distribution Companies. A 15% minimum restocking fee will be made on all merchandise accepted for return on orders correctly filled. Return transportation must be paid by the customer. Requests for returns must be made within 15 days of receipt of the goods.
Contracts: Some items in this catalog are covered under state or federal contracts. Contact us for further information.
Minimum Order: \$25.00

Please note: Prices shown in the catalog are 2024 LIST prices.



Welcome

to The LabMart Distribution Companies, where you will find a large company portfolio with small business service and support. The LabMart Distribution Companies offer a full line of Laboratory Supplies, Equipment and Chemicals from well-known industry brands, and our own LabMart Brand portfolio of quality products at competitive prices to fit all laboratory budgets.

Experience the small business service and support offered by our three distribution companies:

JH Berge, Inc.

Laboratory Product Sales, Inc. (LPS)

Dot Scientific, Inc.

We offer Complete Solutions with Differentiated Services:

- **Storage Solutions:** Certified LN2 Freezer sales and service, Energy Star freezers, refrigeration, racks, barcoded cryogenic vials, freezer boxes, tubes and more
- **Liquid Handling Solutions:** Repair and calibration service, pipettors, tips and accessories
- **Automation Solutions:** Robotic tips, plates, kitting, custom barcoding service

Our diversification includes:

- Minority Owned Small Business certified by NMSDC
- MBE (Minority Business Enterprise)
- WBE (Woman Business Enterprise) certifications through the State of Wisconsin
- SAM registered

The LabMart Distribution Companies offer electronic ordering and billing capabilities and have achieved Top Performer recognition for outstanding performance in the areas of quality, price, delivery, customer support and social responsibility. Our eCommerce platform capabilities include Jaggaer, ESM, IntraMalls, Ariba and Aquire, etc., which are used by large university systems and major pharmaceutical companies across the nation.

Thank you for shopping our Cold Storage Solutions catalog. Our dedicated field sales and customer service teams are here to help you with ALL of your laboratory product needs.

Temperature Chart

MVE Biological Solutions is the leading global manufacturer of cryogenic storage and shipping devices. More than 60 years ago, they set the standard for storage of biological materials at low temperatures. Today, they continue to exceed these standards. Customers from around the world look to MVE for excellence and innovation as they continue to make a vital contribution in today's biomedical Life Sciences industry. In this manner, MVE continues to make a vital contribution in today's biomedical Life Sciences industry.

Maximum temperature for storage of biological samples.

MATERIAL TO BE STORED	VOLUME	CONTAINER	INVENTORY CONFIGURATION	CRITICAL TEMPERATURE
■ Algae	0.5 - 1.0 mL	Cryovial	Boxes or canes	-150°C
- Blood	0.5 - 500 mL	Cryovial/Blood Bag	Boxes or canes/bag rack	-150°C
■ Cells:				
- Animals / Human	0.5 - 1.0 mL	Cryovial	Boxes or canes	-150°C
- Plant	0.5 - 1.0 mL	Cryovial	Boxes or canes	-150°C
- Embryos		Straw	Canes	-150°C
■ Fungi:				
- Mycelium	0.5 - 1.0 mL	Cryovial	Boxes or canes	-150°C
■ Hybridomas	0.5 - 1.0 mL	Cryovial	Boxes or canes	-150°C
■ Phage:	16.00 (406)	16.00 (406)	20.70 (527)	25.13 (638)
- Libraries	0.5 - 1.0 mL	Cryovial	Boxes or canes	-150°C
- Protozoa	0.5 - 1.0 mL	Cryovial	Boxes or canes	-150°C
■ Viruses: Animal In Cells	0.5 - 1.0 mL	Cryovial	Boxes or canes	-150°C

Product Selector Guide

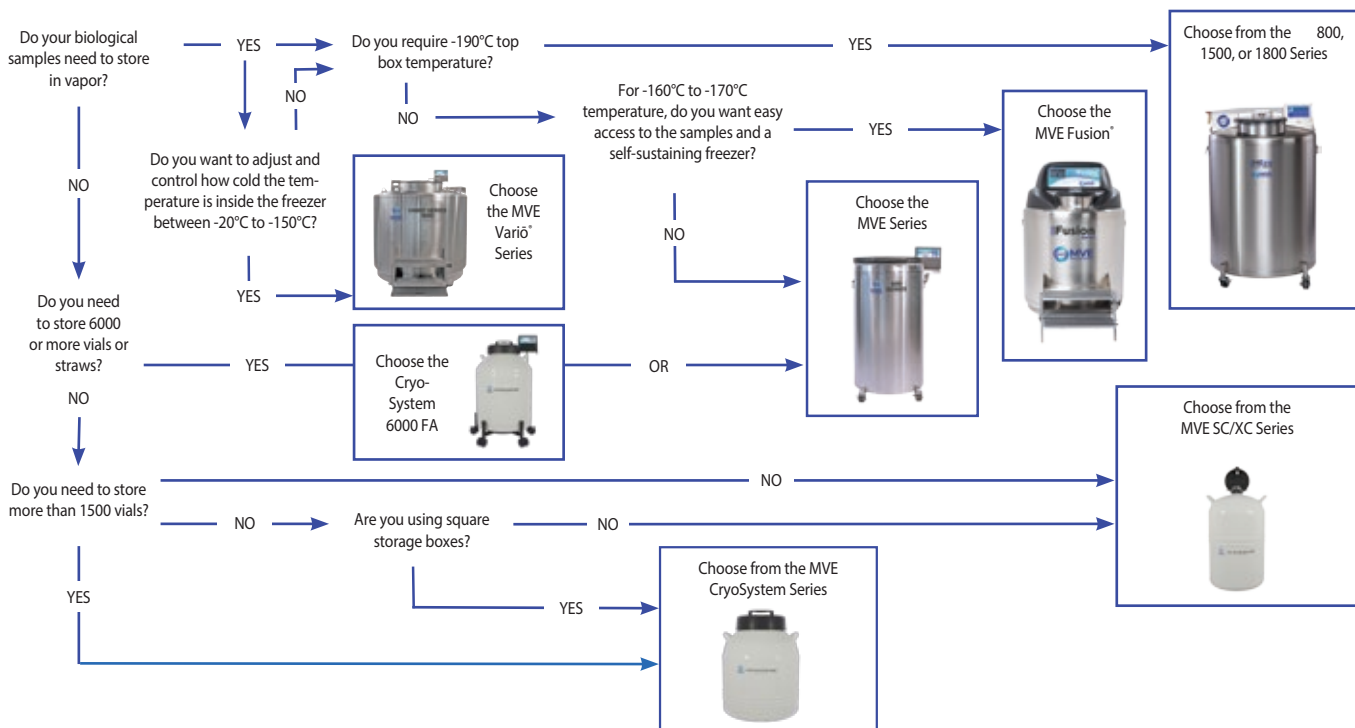

The MVE Fusion® Cryogenic Freezer

The world's first self-sustaining cryogenic freezer

- Long-term dry storage that requires no ongoing LN₂ supply
- Ideal for remote locations, isolated rooms, high elevation facilities, and facilities with limited jacketed pipe infrastructures
- 2 year parts, 5 year vacuum warranty

Eliminate monthly LN₂ costs from your budget!

MVE Fusion® Freezer			
Maximum Storage Capacity			
■ 1.2 & 2 ml Vials (Internally Threaded)	31,200		
■ Number of Racks 100 cell boxes	20		
■ Number of Racks 25 cell boxes	16		
■ Number of Stages per Rack	13		
Performance			
■ LN ₂ Capacity L	50 (inner pressure vessel)		
Unit Dimensions			
■ Neck Opening in. (mm)	12.5 (318)		
■ Usable Internal Height in. (mm)	29.6 (752)		
■ Inner Diameter in. (mm)	38.4 (975)		
■ Overall Height in. (mm)	65 (1625)		
■ Overall Depth in. (mm)	57 (1450)		
■ Liftover Height in. (mm)	37.1 (944)		
■ Door Width Requirement** in. (mm)	43.5 (1105) with handles		
■ Weight Empty est. lb. (kg)	750 (340) estimated		
■ Weight Liquid Full* (Freezer with 50L and Cryocooler) est. lb. (kg)	830 (377) without racks estimated		
Blood Bag Capacities	Total Bags	Bags/Frame	No. Frames
■ 791 OS/U (25 ml)	2296	7	328
■ 4R9951 (50 ml)	1484	7	212
■ 4R9953 (250 ml)	752	4	188
■ 4R9955 (500 ml)	592	4	148
■ DF200 (200 ml)	416	4	104
■ DF700 (700 ml) (will not fit through neck opening)			

FIVE Year Vacuum Warranty • TWO Year Standard Warranty

* Without inventory

**Minimum width required for vessel to pass through opening. Footprint may vary. Contact Tech Service for detailed drawings. Conforms to MDD 93/42/EEC, the Medical Device Directive for the EU. Freezer systems UL/C-UL Listed.



Cat. No.	Description	List Price
21135284	MVE Fusion 1500 with Cryocooler, Hose and 2-tier Step	\$62,528.00
21312104	MVE Fusion Freezer IQOKPQ Validation Package	\$ 2,251.00

Long-term Dry Self-Sustaining Cryogenic Freezer

Assessories

MVE Fusion™ Rack Systems	Description	Cat. No.	List Price
Large Rack (Capacity: 20 Racks)	13-2 LARGE RACK	10544431	\$ 130.00
Mini Rack (Capacity: 16 Racks)	13-2 MINI RACK	10544685	\$ 123.00
MVE Fusion™ Freezer Accessories	Description	Cat. No.	List Price
LN2 Hose w/Safety Relief Valve Standard w/New Fusion	Trans Hose 1/2"x6' OAL TYPE 1-W300PSI RV	10669293	\$ 418.00
LN2 Hose w/o Safety Relief Valve (Only to fill through the neck - Do not connect to Inlet)		9713109	\$ 301.00
Extra Large Phase Separator	1 5/8" Dia. x 4" Long	10615869	\$ 231.00
Relief Valve (Fusion)	Relief Valve	21481696	\$ 119.00
Deflector, for Relief Valve	RV Deflector	11885422	\$ 85.00
Clamp, for Deflector	Clamp	11885431	\$ 6.00
Lid Assy Fusion 1500	Lid w/Ballast Disc & Magnet	21183724	\$2,147.00
Lid Gasket Sold per Foot (3 Feet Required)	EPDM Foam .5" x .75"	20763936	\$ 18.00 per ft
1500 Neck Round Rubber Gasket	Neck Seal Gasket Black	21287912	\$ 381.00
Temperature Probe - MVE T3/TS/ FUSION	Spare Temperature Probe 65" - all freezer models	20570663	\$ 240.00
Temperature Probe w/Certificate of Calibration - (Must be ordered with freezer) Certificate does not certify the calibration of the controller with the sensor installed. Controller calibration is still required.		20570663CAL	\$ 517.00
Battery Cells Only		21081273	\$ 222.00
Muffler 1/4"MPT		11499812	\$ 33.00
Muffler Deflector		11885449	\$ 32.00
Sensor Rubber Plug (Yellow)	Plug for Fusion Sensor Hole	21205789	\$ 3.00
MVE Fusion™ Power Cord	Power Cord Detachable 16/3 SJT, Volex 17502 10 B1	21398542	\$ 30.00



Rack Layout

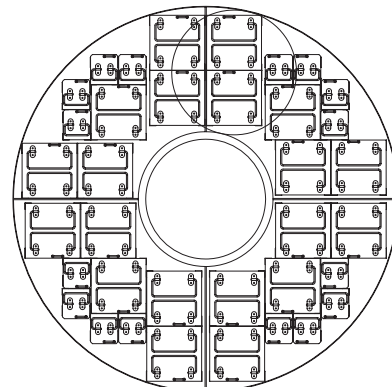

MVE HEco™ Series

With the MVE Touch Screen

- LN₂ efficiency freezers
- Fully enclosed wiring and plumbing
- Vacuum jacketed transfer hose
- Dry sample storage
- -190°C top box temperature
- Low liftover height
- 2 year parts, 5 year vacuum warranty
- Also available with TEC 3000

HEco™ 800 Series with Single Step

Cat. No.	Model Number/Description	Max Qty. Large Racks & 100-place 2" boxes	Max Qty. Mini Racks & 25-place 2" boxes	List Price
21093061	MVE HEco 815P-190AF-TS, 15,600 vial capacity	12 racks, 12 shelves/rack	4 racks, 12 shelves/rack	\$30,076.00
21093058	MVE HEco 818P-190AF-TS, 18,200 vial capacity	12 racks, 14 shelves/rack	4 racks, 14 shelves/rack	\$30,581.00
21093055	MVE HEco 819P-190AF-TS, 19,500 vial capacity	12 racks, 15 shelves/rack	4 racks, 15 shelves/rack	\$30,888.00
20820733	Optional 2-Tier Step			\$ 2,441.00
21107430	Optional HEco 800 Magnetic Lid Lock			\$ 3,125.00

HEco™ 1500 Series with Two-tier Folding Step

Cat. No.	Model Number/Description	Max Qty. Large Racks & 100-place 2" boxes	Max Qty. Mini Racks & 25-place 2" boxes	List Price
21093084	MVE HEco 1536P-190AF-TS, 36,400 vial capacity	24 racks, 13 shelves/rack	16 racks, 13 shelves/rack	\$40,031.00
21093081	MVE HEco 1539P-190AF-TS, 39,200 vial capacity	24 racks, 14 shelves/rack	16 racks, 14 shelves/rack	\$44,706.00
21093078	MVE HEco 1542R-190AF-TS, 42,000 vial capacity	26 racks, 14 shelves/rack	16 racks, 14 shelves/rack	\$45,022.00
21087059	Optional HEco 1500 Magnetic Lid Lock			\$ 3,298.00

HEco™ 1800 Series with Two-tier Folding Step

Cat. No.	Model Number/Description	Max Qty. Large Racks & 100-place 2" boxes	Max Qty. Mini Racks & 25-place 2" boxes	List Price
21093075	MVE HEco 1879P-190AF-TS, 79,950 vial capacity	54 racks, 13 shelves/rack	30 racks, 13 shelves/rack	\$64,954.00
21093072	MVE HEco 1881R-190AF-TS, 81,900 vial capacity	60 racks, 13 shelves/rack	12 racks, 13 shelves/rack	\$70,280.00
21093068	MVE HEco 1892P-190AF-TS, 92,250 vial capacity	54 racks, 15 shelves/rack	30 racks, 15 shelves/rack	\$75,400.00
21093064	MVE HEco 1894R-190AF-TS, 94,500 2mL vial capacity	60 racks, 15 shelves/rack	12 racks, 15 shelves/rack	\$80,493.00
21087060	Optional HEco 1800 Magnetic Lid Lock			\$ 3,454.00

Accessories

Cat. NO.	Description	List Price
11864171	Optional Battery Backup for all HEco models	\$ 1,027.00



Rack Layout

Square Rack Layout (P)

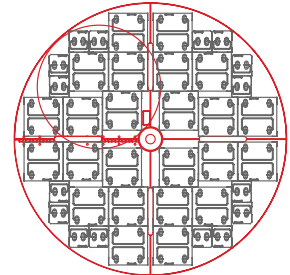

4R9951 Layout (R)

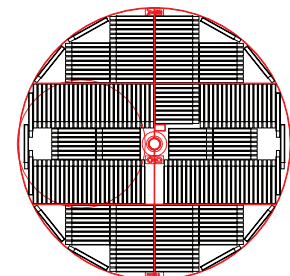

MVE High Efficiency – 190°C Series

With the TEC 3000

- Large LN₂ capacity at vapor platform
- Dry sample storage
- Fully enclosed wiring and plumbing
- Low leftover height
- –190°C top box temperature
- 1500 and 1800 series include 2-tiered steps
- 2 year parts, 5 year vacuum warranty

High Efficiency 800 Series - Stores over 1800 Blood Bags

Cat. No.	Model Number/Description	Max Qty. Large Racks & 100-place 2" boxes	Max Qty. Mini Racks & 25-place 2" boxes	List Price
11369946	MVE 815P-190AF-GB, 15,600 vial capacity	12 racks, 12 shelves/rack	4 racks, 12 shelves/rack	\$30,077.00
13335846	MVE 819P-190AF-GB, 19,500 vial capacity	12 racks, 12 shelves/rack	4 racks, 15 shelves/rack	\$30,888.00
20820733	Optional removable 2-tier step assembly			\$ 2,441.00
13384883	Optional magnetic lid lock assembly			\$ 3,125.00

High Efficiency 1500 Series - Stores over 3100 Blood Bags

Cat. No.	Model Number/Description	Max Qty. Large Racks & 100-place 2" boxes	Max Qty. Mini Racks & 25-place 2" boxes	List Price
11360247	MVE 1536P-190AF-GB, 36,400 vial capacity	24 racks, 13 shelves/rack	16 racks, 13 shelves/rack	\$40,031.00
20538462	MVE 1539R-190AF-GB, 39,200 vial capacity	24 racks, 14 shelves/rack	16 racks, 14 shelves/rack	\$40,189.00
11894505*	MVE 1539P-190AF-GB, 39,200 vial capacity	24 racks, 14 shelves/rack	16 racks, 14 shelves/rack	\$44,707.00
13740104	MVE 1542R-190AF-GB, 42,000 vial capacity	26 racks, 14 shelves/rack	16 racks, 14 shelves/rack	\$45,022.00
13384921	Optional magnetic lid lock assembly			\$ 3,298.00

High Efficiency 1800 Series - Stores over 8400 Blood Bags

Cat. No.	Model Number/Description	Max Qty. Large Racks & 100-place 2" boxes	Max Qty. Mini Racks & 25-place 2" boxes	List Price
13814943	MVE 1879P-190AF-GB, 79,950 vial capacity	54 racks, 13 shelves/rack	30 racks, 13 shelves/rack	\$67,533.00
13371169	MVE 1881R-190AF-GB, 81,900 vial capacity	60 racks, 13 shelves/rack	12 racks, 13 shelves/rack	\$70,280.00
13811849	MVE 1892P-190AF-GB, 92,250 vial capacity	54 racks, 15 shelves/rack	30 racks, 15 shelves/rack	\$75,400.00
13436170	MVE 1894R-190AF-GB, 94,500 vial capacity	60 racks, 15 shelves/rack	12 racks, 15 shelves/rack	\$80,493.00
13384939	Optional magnetic lid lock assembly			\$ 3,454.00

Accessories

Cat. No.	Description	List Price
12885791	Optional Battery backup for all HE models	\$ 1,027.00
21837350	Vacuum Jacketed Hose 3/8" (Hose VJ)	\$ 2,776.00

*also available with rectangular inventory dividers



MVE Variō™ Series

With Touch Screen

- Energy efficient alternative for ULT to cryogenic storage
- Completely dry sample storage
- Consistent temperature even with lid open
- No thermal load; no heat introduced into room and no additional HVAC required
- 2 year parts, 5 year vacuum warranty



MVE Variō™ Series					
	1536P	1539R	1879P	1881R	1894R
Maximum Storage Capacity					
■ 1.2 & 2 ml Vials (Internally Threaded)	36,400	39,000	79,950	81,900	94,500
■ Quantity of Large Racks 100 cell boxes	24	26	54	60	60
■ Quantity of Mini Racks 25 cell boxes	16	16	30	12	12
■ Number of Shelves per Rack	13	13	13	13	15
■ Power consumption (cont.) W	8	8	8	8	8
Unit Dimensions					
■ Neck Opening in. (mm)	17.5 (445)	17.5 (445)	25.0 (635)	25.0 (635)	25.0 (635)
■ Usable Internal Height in. (mm)	28.8 (732)	29.3 (745)	29.5 (749)	29.2 (741)	34.2 (868)
■ Inner Diameter in. (mm)	38.5 (978)	38.5 (978)	56.0 (1,422)	54.8 (1,391)	54.8 (1,391)
■ Overall Height in. (mm)	61.3 (1,556)	61.3 (1,556)	62.1 (1,577)	61.3 (1,556)	66.3 (1,683)
■ Door Width Requirement (mm)	42.0 (1,067)	42.0 (1,067)	60.0 (1,524)	60.0 (1,524)	60.0 (1,524)
■ Weight Empty lb. (kg)	690 (313)	690 (313)	1,606 (728)	1,721 (781)	1,721 (781)

Blood Bag Capacities	Total Bags			Total Bags			Total Bags			Total Bags			Total Bags		
	Bags/Frame	No. Frames		Bags/Frame	No. Frames		Bags/Frame	No. Frames		Bags/Frame	No. Frames		Bags/Frame	No. Frames	
■ 791 OS/U Medsep (25 ml)	3,080	7	440	2,786	7	398	5,866	7	838	5,628	7	804	6,432	8	804
■ 4R9951 (50 ml)	1,488	6	248	1,446	6	241	2,952	6	492	2,940	6	490	3,920	8	490
■ 4R9953 (250 ml)	812	4	203	768	4	192	1,584	4	396	1,608	4	402	2,010	5	402
■ 4R9955 (500 ml)	608	4	152	576	4	144	1,104	4	276	1,240	4	310	1,550	5	310
■ DF200 (200 ml)	496	4	154	488	4	122	960	4	240	984	4	246	1,230	5	246
■ DF700 (700 ml)	256	4	64	204	4	66	504	4	126	544	4	136	680	5	136

MVE Variō™ 1500 with Touch Screen		
Cat. No.	Model Number/ Description	List Price
21000856	MVE Variō 1536P-TS	\$42,092.00
21000854	MVE Variō 1539R-TS	\$42,912.00
13384921	Optional Magnetic Lid Assembly Lock	\$ 3,298.00

MVE Variō™ 1800 with Touch Screen		
Cat. No.	Model Number/ Description	List Price
21000851	MVE Variō 1879P-TS	\$72,138.00
21000852	MVE Variō 1881R-TS	\$75,002.00
21000857	MVE Variō 1894R-TS	\$81,947.00
13384939	Optional Magnetic Lid Assembly Lock	\$ 3,454.00

Accessories		
Cat. No.	Description	List Price
12885791	Optional Battery backup for all Variō models	\$ 1,027.00
21837350	Vacuum Jacketed Hose 3/8" (Hose VJ)	\$ 2,776.00

Rack Layout
Square Rack Layout (P)

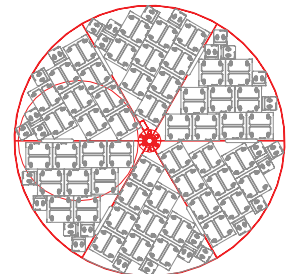

4R9951 Layout (R)

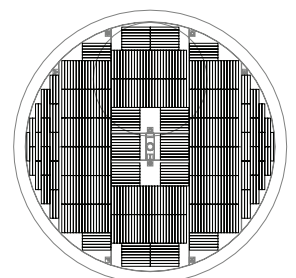

STANDARD
OPTIONAL

MVE Series

With TEC 3000

- Large LN₂ capacity
- Liquid sample storage
- Wide neck opening
- Low liftover height
- 2 year parts, 5 year vacuum warranty

MVE Series					
	MVE 205	MVE 510	MVE 616	MVE 1426	MVE 1839
Maximum Storage Capacity					
■ 1.2 & 2 ml Vials (Internally Threaded)	5,200	10,400	16,900	26,650	39,000
■ Number of Racks 100 cell boxes	4	7	12	18	28
■ Number of Racks 25 cell boxes	-	4	4	10	8
■ Number of Stages per Rack	13	13	13	13	13
■ LN ₂ Capacity L	95	166	240	388	673
Unit Dimensions					
■ Neck Opening in. (mm)	16.00 (406)	20.70 (527)	25.10 (638)	31.75 (806)	39.40 (1002)
■ Usable Internal Height in. (mm)	28.9 (735)	30.0 (762)	29.5 (749)	29.3 (745)	33.6 (854)
■ Inner Diameter in. (mm)	16.00 (406)	20.70 (527)	25.1 (638)	31.75 (806)	39.40 (1002)
■ Overall Height w/ AutoFill in. (mm)	46.3 (1176)	46.7 (1185)	45.8 (1161)	46.8 (1188)	54.0 (1372)
■ Door Width Requirement** in. (mm) Outer Dimensions	23.6x22.7 (601x577)	30.6x29.7 (778x754)	33.5x34.6 (852x878)	40x41.6 (1017x1056)	46.8x48.9 (1187x1242)
■ Weight Empty lb. (kg)	195 (88)	281 (127)	320 (145)	490 (222)	750 (341)
■ Weight Liquid Full* lb. (kg)	365 (166)	577 (262)	748 (339)	1181 (536)	1950 (885)

Blood Bag Capacities	Total Bags			Total Bags			Total Bags			Total Bags			Total Bags		
	Bags/Frame	No. Frames	No. Frames	Bags/Frame	No. Frames	No. Frames	Bags/Frame	No. Frames	No. Frames	Bags/Frame	No. Frames	No. Frames	Bags/Frame	No. Frames	No. Frames
■ 791 OS/U Medsep (25 ml)	539	7	77	882	7	126	1,372	7	196	2,226	7	318	3,968	8	496
■ 4R9951 (50 ml)	228	6	38	420	6	70	612	6	102	924	6	154	1,856	8	232
■ 4R9953 (250 ml)	128	4	32	224	4	56	336	4	84	512	4	128	1,010	5	202
■ 4R9955 (500 ml)	96	4	24	160	4	40	248	4	62	424	4	106	770	5	154
■ DF200 (200 ml)	80	4	20	128	4	32	200	4	50	336	4	84	610	5	122
■ DF700 (700 ml)	40	4	10	68	4	17	116	4	29	168	4	42	380	5	76

MVE Series		
Cat. No.	Model Number/ Description	List Price
11004373	MVE 205AF-GB	\$14,625.00
10544837	Optional Vapor Platform	\$ 518.00
11905075	MVE 510AF-GB	\$12,781.00
10544853	Optional Vapor Platform	\$ 614.00
11527342	MVE 616AF-GB	\$13,864.00
11509726	Optional Vapor Platform	\$ 604.00
11655301	MVE 1426AF-GB	\$21,405.00
10544888	Optional Vapor Platform	\$ 718.00
11922449	MVE 1839AF-GB	\$30,062.00
10544909	Optional Vapor Platform	\$ 1,010.00

Accessories		
11864171	Optional Battery backup for all MVE models	\$ 1,027.00
21837350	Vacuum Jacketed Hose 3/8" (Hose VJ)	\$ 2,776.00



Rack Layout

4R9953 Layout

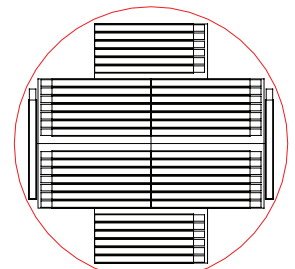

DF700 Layout

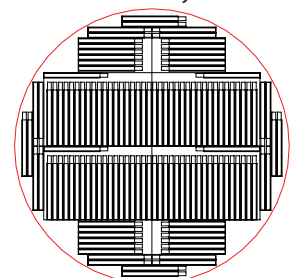

Vapor Phase MVE Stock Series - 2T Models

With TEC 3000

- Low liftover height • Large LN₂ Capacity
- Optional Battery Backup
- 2 year parts, 5 year vacuum warranty



Vapor Phase MVE Stock Series - 2T Models				
	MVE 103	MVE 816P-2T-190	MVE 1842P-150	MVE 1877P-2T-150
Maximum Storage Capacity				
■ 1.2 & 2 ml Vials (Internally Threaded)	—	10,500	—	—
■ High Security Straw Capacity (0.5 ml)	7,728	31,584	—	347,424
■ Number of Canisters (73 mm)	23	94	—	517
■ Goblets/Canister : Straws/Goblet	2:168	2:168	2:168	4:168
■ Number of SUC-1 Canisters (2.5"x2.5"x11)	22	115	294	539
■ Number of 1.2 ml Vials on Canes	3,168	16,560	42,336	77,616
■ Number of 2.0 ml Vials on Canes	1,760	9,200	23,520	43,120
■ Number of 1/2 cc Straws 10/cane	6,820	35,650	91,140	167,090
■ LN ₂ Capacity at Platform Vapor L est.	-	56	-	250
■ LN ₂ Capacity w/o Inventory L est.	39	381	872	1456
Unit Dimensions				
■ Neck Opening in. (mm)	16.0 (406)	12.5 (317)	25.0 (635)	25.0 (635)
■ Usable Internal Height in. (mm)	12.0 (305)	13.0 (330) per level	13.0 (330)	13.0 (330) per tray
■ Inner Diameter in. (mm)	16.00 (406)	28.70 (728) top tier 27.70 (702) bottom tier	56.1 (1425)	56.25 (1429) top and bottom tiers
■ Overall Height with Auto Fill in. (mm)	16.4 (415)	58.0 (1473)	51.1 (1296)	64.6 (1639)
■ Door Width Requirement in. (mm) Outer Dims	18 (457)	32 (813)	60 (1524)	60 (1524)
■ Weight Empty lb. (kg)	48 (22)	475 (215)	1167 (530)	1721 (781)
■ Weight Liquid Full lb. (kg) est.	117 (53)	1155 (524)	2721 (1234)	4316 (1958)

Rack Layouts

115 SUC Boxes Total

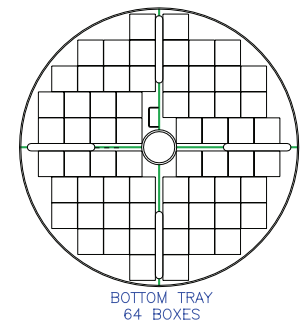
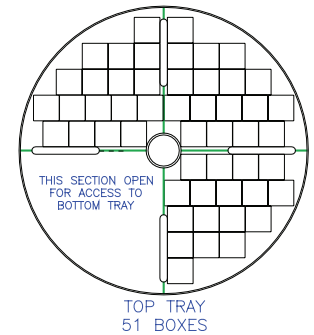

Vapor Phase MVE Stock Series - 2T Models		
Cat. No.	Model Number/Description	List Price
13476657	MVE 816P-2T-190AF-GB	\$34,484.00
13820981	MVE 1877-2T-150AF-GB	\$66,360.00
12885791	Optional Battery backup	\$ 1,027.00
21837350	Vacuum Jacketed Hose 3/8" (Hose VJ)	\$ 2,776.00

Cryogenic Freezers for In Vitro Fertilization

Liquid Phase MVE Stock Series

With TEC 3000

- Designed for liquid storage, but most MVE Stock Series can be used to store in vapor*
- 2 year parts, 5 year vacuum warranty

Liquid Phase MVE Stock Series		
Cat. No.	Model Number/Description	List Price
9918669	MVE 103, no TEC 3000, lift off lid	\$ 5,952.00
13817440	MVE 1842P-150-150AF-GB	\$54,115.00
20969812	Canister SQ SS MVE 5-2 Large for 1842 models	\$ 129.00

* Verify temperature requirements if you are going to store vapor in the MVE or Stock Series.



Tank Features
816P-2T-190

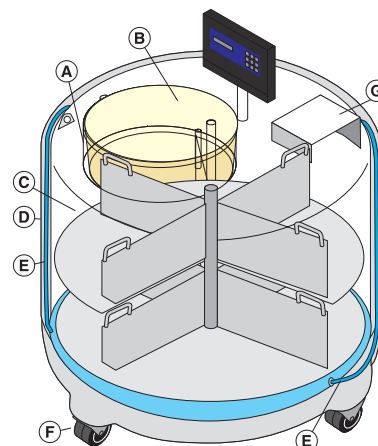

- A** Offset neck design minimizes liquid nitrogen consumption
- B** Lightweight composite lid is scratch and dent resistant
- C** Two level rotating tray provides easy access to samples
- D** Stainless steel construction reduces maintenance
- E** Annular (internal) filling lines minimize frost build up and reduces maintenance requirements
- F** Durable casters equipped with brakes
- G** Lid Stand

MVE CryoCart/ Workbench

- Approximate hold time of 18 hours with lid on
- Temperature monitor with type T Thermocouple
- Traceable calibration certificate with RS232 PC interface
- LN₂ transfer hose connection with ball valve and relief valve



Cat. No.	Description	List Price
14448703	MVE Cryo Cart	\$22,694.00

Cool Reach Retrieval Tool

- Retrieves sample vials, etc. that have fallen into LN₂



Cat. No.	Description	List Price
13051579	Cool Reach - Retrieval Tool - 40" (includes handle)	\$ 286.00



MVE - SC (Standard Capacity) Series - Compact Aluminum Dewar

- Long term liquid storage and preservation
- Popular for IVF
- Low LN₂ consumption
- Strong, lightweight construction
- 2 year parts, 5 year vacuum warranty
- SC 20/20 includes Bend Don't Break™ durability feature



MVE SC Series	BEST SELLER		
	SC 3/3	SC 11/7	SC 20/20 Signature
Maximum Storage Capacity			
■ Number of Canisters	6	6	6
■ Number of 1/2 cc straws 10/cane	—	660	660
■ Number of 1/2 cc straws 1 Level Bulk	440	879	879
■ Number of 1/4 cc straws	—	210	210
■ LN ₂ Capacity L	3.6	11.0	20.5
■ Static Evaporation Rate L/day	0.13	0.16	0.085
■ Static Holding Time days	17	43	150
Unit Dimensions			
■ Neck Opening in. (mm)	2.18 (55)	2.18 (55)	2.16 (55)
■ Overall Height in. (mm)	16.0 (406)	21.6 (549)	26.0 (660)
■ Outer Diameter in. (mm)	8.7 (222)	10.2 (260)	14.5 (368)
■ Canister Height in. (mm)	5.0 (127)	11.0 (279)	11.0 (279)
■ Canister Diameter in. (mm)	1.65 (41.9)	1.65 (41.9)	1.65 (41.9)
■ Weight Empty lb. (kg)	8 (3.6)	17 (7.7)	22.5 (10.2)
■ Weight Full lb. (kg)	14.4 (6.5)	36.6 (16.6)	58.99 (26.7)

Tank Features

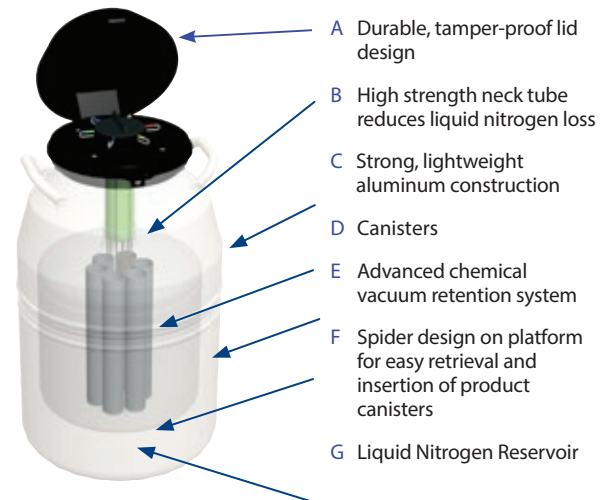

MVE SC Series		
Cat. No.	Model Number/Description	List Price
9918009	SC 3/3 with (6) 5" (127 mm) canisters	\$1,193.00
9918499	SC 11/7 with (6) 11" (279mm) canisters	\$1,223.00
20861774	SC 20/20 SIGNATURE with (6) 11" (279mm) canisters	\$1,463.00
10829621	SC 35/24 with (6) 11" (279mm) canisters	\$1,969.00
10937403	Roller Based for SC 35/24 (required)	\$ 415.00
10623201	Center canister for SC 20/20, XC-20, 35/24, 11/7	\$ 53.00

MVE - XC (Extra Capacity) Series - Aluminum Dewar

- Long term liquid storage and preservation
- Popular for IVF
- Low LN₂ consumption
- Strong, lightweight construction
- 2 year parts, 5 year vacuum warranty



MVE - XC Series		BEST SELLER					
	XC 20 Signature	XC 32/8	XC 33/22	XC 34/18	XC 47/11-6SQ	XC 47/11-6	XC 47/11-10
Maximum Storage Capacity							
■ Number of Canisters	6	9	6	6	6 sq.	6	10
■ Number of 1/2 cc Straws 10/cane	660	2,520	1,260	2,100	—	4,500+	3,500
■ Number of 1/2 cc Straws 1 Level Bulk	879	3,960	1,764	3,000	—	6,216	5,000
■ Number of 1/2 cc Straws 2 Level Bulk	1,680	—	—	630	—	1,320	1,050
■ Number of 1.2 & 2.0 ml Vials 5/cane	210	855	360	—	750	—	—
■ LN ₂ Capacity L	20.5	32.0	33.4	34.8	47.4	47.4	47.4
■ Static Evaporation Rate L/day	0.090	0.35	0.14	0.18	0.39	0.39	0.39
■ Normal Working Duration, Full Days	142	57	154	123	76	76	76
Unit Dimensions							
■ Neck Opening in. (mm)	2.18 (55.4)	3.81 (97)	2.75 (70)	3.50 (89)	5.00 (127)	5.00 (127)	5.00 (127)
■ Overall Height in. (mm)	26.0 (660)	21.5 (546)	26.0 (660)	26.6 (675)	26.5 (673)	26.5 (673)	26.5 (673)
■ Overall Inner Height in. (mm)	—	—	—	—	—	—	—
■ Outer Diameter in. (mm)	14.5 (368)	18.2 (464)	18.2 (464)	18.2 (464)	20.0 (508)	20.0 (508)	20.0 (508)
■ Canister Height in. (mm)	11/5 (279/127)	11 (279)	111 (279)	11 (279)	—	11 (279)	11 (279)
■ Canister Diameter in. (mm)	1.65 (41.9)	2.62 (67)	2.22 (56)	2.81 (71)	—	4.00 (102)	2.81 (71)
■ Weight Empty lb. (kg)	22 (10)	30 (13.6)	34 (15.4)	34 (15.4)	42 (19.0)	42 (19.0)	42 (19.0)
■ Weight Full lb. (kg)	58.4(26.5)	87.0 (39.5)	94.0 (42.5)	96.0 (43.5)	120.4 (54.6)	120.4 (54.6)	120.4 (54.6)



MVE XC Series		
Cat. No.	Model Number/Description	List Price
20997986	XC 20 Signature Series with (6) 11" (279mm) canisters	\$1,219.00
9918449	XC 32/8 with (9) 11" (279mm) canisters	\$2,241.00
9918069	XC 33/22 with (6) 11" (279mm) canisters	\$1,829.00
10743027	XC 34/18 with (6) 11" (279mm) canister	\$1,781.00
10719924	XC 47/11-6 with (6) 11" (279mm) canisters	\$2,304.00
13346449	XC 47/11-6SQ with (6) mini square rack, (2" Mini Boxes) 5-Tier-25 cell	\$2,993.00
10725435	XC 47/11-10 with (10) 11" (279mm) canisters	\$2,340.00
10937391	Roller Base - XC20 Signature Series	\$ 415.00
10937403	Roller Base - XC 32/8, XC 33/22, XC 34/18	\$ 415.00
10937411	Roller Base - XC 47/11-6, XC 47/11-6SQ, XC 47/11-10	\$ 415.00

Tank Features



MVE CryoSystem Series

- Medium vial storage capacity
- Low liquid nitrogen consumption
- 2 year parts, 3 year vacuum warranty



MVE CryoSystem Series				BEST SELLER
	CryoSystem 750	CryoSystem 2000	CryoSystem 4000	CryoSystem 6000
Maximum Storage Capacity				
■ Number of Canisters	6	4	4	6
■ Number of 1.2 & 2.0 ml vials 100/box	—	2,000	4,000	6,000
■ Number of 1.2 & 2.0 ml vials 25/box	750	—	—	—
■ Boxes per Rack	5	5	10	10
■ LN ₂ Capacity w/o Inventory L est.	47	61	121	175
■ LN ₂ Capacity w/Inventory L est.	45	51	111	150
■ Static Evaporation Rate L/day	0.39	0.85	0.99	0.99
■ Working Duration Full Days	76	38	66	104
Unit Dimensions				
■ Neck Opening in. (mm)	5.0 (127)	8.5 (216)	8.5 (216)	8.5 (216)
■ Overall Height in. (mm)	26.50 (673)	27.25 (692)	38.00 (965)	37.9 (963)
■ Outer Diameter in. (mm)	20 (508)	22 (559)	22 (559)	26.5 (673)
■ Weight Empty lb. (kg)	42 (19.0)	58 (26.3)	81 (36.7)	103 (46.7)
■ Weight Full lb. (kg)	126 (57)	182 (82.5)	300 (136)	425 (193)

MVE CryoSystem Series		
Cat. No.	Model Number/Description	List Price
11886450	Cryosystem 750 with (6) inventory racks for (30) mini boxes	\$ 2,959.00
10650200	Cryosystem 2000 with (4) inventory racks for (20) large boxes	\$ 4,757.00
10650197	Cryosystem 4000 with (4) inventory racks for (40) large boxes	\$ 5,434.00
10718067	Cryosystem 6000 with (6) inventory racks for (60) large boxes	\$ 6,130.00
10937411	Roller Base - Cryosystem 750	\$ 415.00
10937420	Roller Base - Cryosystem 2000 and 4000	\$ 415.00
10937438	Roller Base - Cryosystem 6000	\$ 415.00
14796775	Cryosystem 6000 Full Auto w/TEC3000/Roller Base/Transfer Hose with 6 racks for (60) large boxes	\$12,019.00

Tank Features

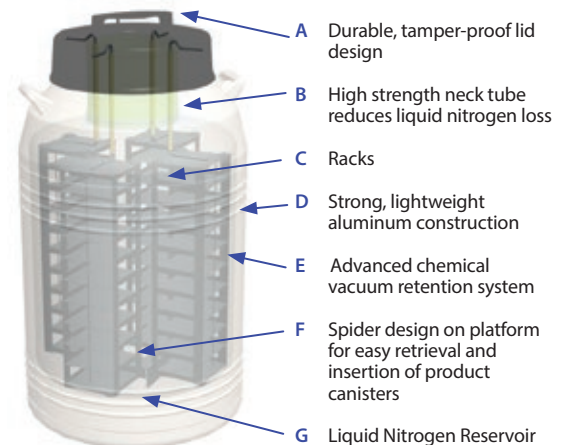

MVE Research Dewars

- Small thermal dewar for temporary storage
- For easy, safe transport of LN₂ and samples within facilities
- All stainless steel construction
- Vacuum-insulated for long static hold times
- 90 day warranty
- Lids sold separately



MVE Research Dewars						
	RD-6	RD-3	RD-2	RD-1	RD-1W	RD-0.5
Performance						
■ LN ₂ Capacity L est.	6	3	2	1	1	0.5
■ Handle	yes	yes	yes	yes	yes	no
Unit Dimensions						
■ Neck Opening in. (mm)	7.3 (185)	7.3 (185)	3.9 (99)	3.3 (84)	3.9 (99)	2.6 (66)
■ Inner Diameter in. (mm)	7.3 (185)	7.3 (185)	3.9 (99)	3.3 (84)	3.9 (99)	2.6 (66)
■ Outside Diameter in. (mm)	7.8 (198)	7.8 (198)	4.8 (122)	4.3 (109)	4.8 (122)	3.4 (86)
■ Usable Internal Height in. (mm)	10.6 (269)	6.3 (160)	7.1 (180)	6.2 (157)	6.1 (155)	7.1 (180)
■ Overall Height in. (mm)	11.8 (300)	7.5 (191)	12.3 (312)	9.1 (231)	7.0 (178)	8.0 (203)
■ Weight Empty lb. (kg)	4.4 (2.0)	3.3 (1.5)	1.8 (0.8)	1.1 (0.5)	1.1 (0.5)	0.7 (0.3)
■ Weight Liquid Full lb. (kg)	15.0 (6.8)	8.6 (3.9)	5.3 (2.4)	2.9 (1.3)	2.9 (1.3)	1.5 (0.7)
■ NER without Cover L/Hr	0.4	0.2	0.1	0.1	0.2	0.1

MVE Research Dewars		
Cat. No.	Model Number/Description	List Price
13982242	0.5 Liter Dewar	\$ 699.00
1392251	1.0 Liter Dewar	\$ 787.00
13982269	1.0 Liter Dewar (Wide Mouth)	\$ 787.00
13982277	2.0 Liter Dewar	\$ 953.00
13982285	3.0 Liter Dewar	\$1,490.00
13982293	6.0 Liter Dewar	\$1,738.00
13976344	Spare Cork and Cover for RD-0.5	\$ 228.00
13976379	Spare Cork and Cover for RD-1	\$ 228.00
13976387	Spare Cork and Cover for RD-1W and RD-2	\$ 228.00
21007715	Stainless Steel Lid Only for RD-3 and RD-6	\$ 228.00

POPULAR!

MVE Lab Series Liquid Dewars

- Convenient storage and dispensing of LN₂
- Super insulated for low LN₂ consumption
- Dispensing devices available
- 2 year parts, 5 year vacuum warranty



MVE Lab Series Liquid Dewars

	LAB 4	LAB 5	LAB 10	LAB 20	LAB 30	LAB 50
Performance						
■ LN ₂ Capacity L	4	5	10	20	32	50
■ Static Evaporation Rate* L/day	0.19	0.15	0.18	0.18	0.22	0.49
Unit Dimensions						
■ Neck Opening in. (mm)	1.40 (35)	2.18 (56)	2.18 (56)	2.18 (56)	2.50 (64)	2.50 (64)
■ Useable Height in. (mm)	7.8 (198)	10.5 (266)	13.5 (343)	13.7 (348)	14.9 (378)	22.0 (559)
■ Overall Height in. (mm)	16.8 (426)	18.2 (462)	21.5 (546)	24.5 (622)	24.0 (610)	30.5 (775)
■ Outer Diameter in. (mm)	7.3 (185)	8.8 (222)	10.3 (260)	14.5 (368)	17.0 (432)	17.0 (432)
■ Internal Diameter in. (mm)	5.5 (139)	6.5 (165)	8.3 (210)	11.4 (289)	14.0 (356)	14.0 (356)
■ Weight Empty lb. (kg)	6 (2.7)	8 (4)	12 (5.4)	19 (9)	25 (11.4)	31 (14)
■ Weight Full lb. (kg)	13 (6)	17 (8)	31 (14)	55 (25)	82 (37.2)	120 (54.4)

MVE Lab Series Liquid Dewars

Cat. No.	Model Number/Description	List Price	Cat. No.	Model Number/Description	List Price
9922219	Lab 4 Unit, 4L Capacity	\$ 989.00	9711929	Pouring Spout for Lab 30 and Lab 50	\$268.00
9918079	Lab 5 Unit, 5L Capacity	\$ 894.00	10668101	Manual Discharge Device for Lab 10	\$976.00
10740281	Lab 10 Unit, 10L Capacity	\$ 943.00	13484139	Manual Discharge Device for Lab 20	\$971.00
13492631	Lab 20 Unit, 20L Capacity	\$1,223.00	10668004	Manual Discharge Device for Lab 30	\$971.00
9918099	Lab 30 Unit, 30L Capacity	\$1,450.00	10668021	Manual Discharge Device for Lab 50	\$971.00
9918109	Lab 50 unit, 50L Capacity	\$1,973.00	10937391	Roller Base for Lab 20	\$ 415.00
9720729	Pouring Spout for Lab 5, Lab 10 and Lab 20	\$ 268.00	10937403	Roller Base for Lab 30 or Lab 50	\$ 415.00

MVE Doble Series

- Charge the absorbent layer in base of tank to use Doble as vapor shipper
- Fill with LN₂ for long-term sample storage
- Use with protective shipping containers to ensure upright transport
- Straw or vial shipping and storage
- 2 year parts, 3 year vacuum warranty
- Liquid and Vapor Storage Options Available



MVE Doble Series							
	Doble 11	Doble 20	Doble 22	Doble 28	Doble 34	Doble 47-6	Doble 47-10
Maximum Storage Capacity							
■ Number of Canisters	6	6	6	6	6	6	10
■ No. of 1/2 cc Straws 10/cane	660	660	2400	2,400	2,100	4,500	3,500
■ Vial Capacity	210	210	810	810	630	1,320	1,050
■ LN ₂ Capacity w/o Inventory L est.	10.0	18.5	20.0	28.0	32.0	46.0	46.0
■ Vapor Capacity L	3.1	4.2	5.5	8.4	7.9	6.0	6.0
■ Static Evaporation Rate L/day	0.17	0.10	0.35	0.35	0.20	0.40	0.40
■ Working Duration days for liquid	37	116	40	50	110	74	72
■ Working Duration days for vapor	17	21	18	21	21	21	21
Unit Dimensions							
■ Neck Opening in (mm)	2.18 (55)	2.18 (55)	3.81 (97)	3.81 (97)	3.50 (89)	5.00 (127)	5.00 (127)
■ Overall Height in (mm)	21.6 (549)	25.5 (647)	22 (559)	22 (559)	26.6 (676)	26.5 (673)	26.5 (673)
■ Outside Diameter in (mm)	10.2 (260)	14.5 (368)	14.5 (368)	18.2 (462)	18.2 (462)	20.0 (508)	20.0 (508)
■ Canister Height in (mm)	11 (279)	11 (279)	11 (279)	11 (279)	11 (279)	11 (279)	11 (279)
■ Canister Diameter in (mm)	1.65 (42)	1.65 (42)	3.09 (79)	3.09 (79)	2.81 (72)	4.00 (101)	2.81 (72)
■ Weight Empty lb. (kg)	14.5 (6.6)	23 (10.4)	23.8 (10.7)	33 (15.0)	34.5 (15.6)	41 (18.5)	41 (18.5)
■ Weight Charged vapor lb. (kg)	19.5 (8.8)	30.3 (13.7)	35 (15.8)	47 (21.3)	47.9 (21.7)	54.6 (24.7)	54.6 (24.7)
■ Weight Full liquid lb. (kg)	32 (14.5)	56 (25.4)	68 (30.8)	89 (40.4)	92 (41.7)	117 (53.1)	117 (53.1)
■ Protective Shipping Container Part No.	20750519	11912460	20750520	11930861	20863878	14035731	14035731

MVE Doble Series		
Cat. No.	Model Number/Description	List Price
11507886	Doble 11 with (6) 11" Canisters	\$1,519.00
20750519	Doble 11 Protective Shipping Container	\$ 609.00
11492151	Doble 20 with (6) 11" Canisters	\$1,530.00
11912460	Doble 20 Protective Shipping Container	\$ 774.00
20937586	Doble 22 with (6) 11" Canisters	\$2,362.00
20750520	Doble 22 Protective Shipping Container	\$ 774.00
10937391	Doble 22 Roller Base	\$ 415.00

MVE Doble Series		
Cat. No.	Model Number/Description	List Price
11527730	Doble 28 with (6) 11" Canisters	\$2,502.00
11930861	Doble 28 Protective Shipping Container	\$ 965.00
11497948	Doble 34 with (6) 11" canisters	\$2,154.00
20863878	Doble 34 Protective Shipping Container	\$ 924.00
11498684	Doble 47-6 with (6) 11" Canisters	\$2,788.00
11554308	Doble 47-10 with (10) 11" Canisters	\$2,808.00
14035731	Doble 47-6 and 47-10 Protective Shipping Container	\$ 924.00

MVE Vapor Shipper Series

- Charge the absorbent layer in base of tank for dry sample shipping
- Use with protective shipping containers to ensure upright transport
- 1/4 and 1/2cc straws, blood bag or vial shipping
- 2 year parts, 3 year vacuum warranty



MVE Vapor Shipper Series	SC 2/1V	SC 4/2V	SC 4/3V	XC 30/12V	Cryo-Shipper	VERY POPULAR Cryo-Shipper XC	VERY POPULAR CryoShipper 2000	IATA	65/5V
Maximum Storage Capacity									
■ No. of Canisters	1	1	1	1	1 Rack	—	4 square racks	Stainless Steel Secondary Container Dimensions: 7-3/8" diameter 8-3/4" deep	1x 5/2 vial box rack (100 vials/box)
■ No. of 1/2 cc Straws 10/cane	—	280	120	60		—	5 boxes per rack 2,000 total 1.2mL & 2.0mL vials (100/box)		
■ No. of 1/2 cc Straws 1 Level Bulk	88	44	210	312		—			
■ No. of 1/4 cc Straws 1 Level Bulk	182	938	452	660		—			
■ No. of 1.2 & 2.0 ml Vials 5/cane	—	95	40	30		—			
■ No. of 1.2 & 2.0 ml Vials 6/cane	—	102	48	36		500			
■ No. of blood bags stored 4R9953	—	—	—	—	10	10			
Performance (Hold Time overrides NER specifications)									
■ LN ₂ Capacity L	1.5	3.6	4.3	18	8.5	10.0	65	10.0	27.4
■ Static Holding Time Days	8	13	21	82	10	14	15	14	40
■ Static Evaporation Rate L/day	0.19	0.26	0.20	0.22	0.85	0.70	.79	0.70	0.79
Unit Dimensions									
■ Neck Opening in. (mm)	1.40 (35.0)	2.75 (70.0)	2.00 (51.0)	2.00 (51.0)	8.50 (216.0)	8.50 (216.0)	8.5 (216)	8.50 (216.0)	8.50 (216.0)
■ Overall Height in. (mm)	13.5 (343)	18.4 (468)	19.4 (492)	24.3 (617)	21.5 (546)	23.0 (584)	27.2 (692)	23.0 (584)	27.3 (694)
■ Outer Diameter in. (mm)	7.25 (184)	8.70 (222)	8.70 (222)	17.0 (432)	14.50 (369)	15.00 (381)	22.0 (559)	15.00 (381)	22 (559)
■ Canister Height in. (mm)	5.0 (127)	11.0 (279)	11.0 (279)	11 (279)	11.0 (279)	12.5 (317.5)	—	8.75 (222.25)	—
■ Canister Diameter in. (mm)	1.20 (31)	2.62 (67)	1.81 (46)	1.96 (50)	5.6 (142) x 6.6 (167)	8.5 (216)	—	7.375 (187.325)	—
■ Weight Empty lb. (kg)	6.0 (2.7)	10.0 (4.5)	11.6 (5.3)	44 (20)	26.1 (11.8)	33.0 (15.0)	65 (29.5)	33.0 (15.0)	74.5 (33.9)
■ Weight Charged lb. (kg)	8.0 (3.6)	17.1 (7.7)	19.1 (8.7)	76 (34)	39.0 (17.7)	49.0 (22.2)	95 (43.1)	49.0 (22.2)	145.5 (66.2)
■ Weight Full lb. (kg)	9.0 (4.1)	20.0 (9.1)	21.0 (9.5)	82 (37.2)	54.5 (24.7)	73.0 (33.1)	185 (83.9)	73.0 (33.1)	185 (83.9)
■ Protective Shipping Container Part No.	20750408 \$557.00	20750409 \$557.00	20750409 \$557.00	21325842 \$893.00	20750520 \$624.00	10741726 \$897.00	12875162 \$960.00	10741726 \$897.00	12875162 \$960.00

MVE Vapor Shipper Series			MVE Vapor Shipper Series		
Cat. No.	Model Number/Description	List Price	Cat. No.	Model Number/Description	List Price
9922339	SC2/1 V with (1) 5" (127mm) Canister	\$1,444.00	10777411	IATA Cryoshipper includes Cryoshipper XC, secondary container and shipping container with labeling	\$6,263.00
9918479	SC4/2 V with (1) 11" (279mm) Canister	\$1,484.00			
10817330	SC4/3 V with (1) 11" (279mm) Canister	\$1,516.00			
21244576	XC30/12V with (1) 11" (279mm) Canister	\$2,694.00			
11366673	Cryoshipper 2000	\$4,357.00	21532115	Data Logger Lid Assemblies installed on dewar cork and cover: Cryoshipper XC; Cryoshipper	\$2,249.00
10508967	Cryoshipper w/Blood Bag Rack (w/shipping container)	\$4,391.00	21553216S	Data Logger Lid Assemblies installed on dewar cork and cover: SC 4 / 2 V	\$2,212.00
20925284	Cryoshipper w/5-2 SQ Rack (w/shipping container)	\$4,391.00	21553217S	Data Logger Lid Assemblies installed on dewar cork and cover: SC 4 / 3 V	\$2,212.00
11015195	Cryoshipper Extra Capacity (XC) w/o rack (w/shipping container)	\$4,356.00			



MVE CryoCube™ and BL-7

- One-way cryogenic shipping
- Operates as a dry shipper
- Ship in any orientation – doesn't have to be upright!
- Save on dry ice, packaging, shipping and disposal costs
- One year vacuum warranty



MVE Blood Bag Shippers

- Safe for international shipping: IATA dangerous goods regulations exempt
- Two year vacuum warranty

MVE CryoCube™ & BL-7

	MVE CryoCube™	MVE BL-7
Maximum Storage Capacity		
■ Number of Canisters	1	1
■ Number of 1/2 cc Straws 1 Level Bulk	182	270
■ LN ₂ Capacity w/o Inventory L est.	1.5	2.1
■ Static Holding Time* days	5	7
Unit Dimensions		
■ Neck Opening in. (mm)	1.4 (35)	1.97 (50)
■ Overall Height in. (mm)	12.5 (317.5)	15.0 (381)
■ Overall Width in. (mm)	12 (305)	12.64 (321)
■ Overall Diameter in. (mm)	1.25 (32)	1.50 (38)
■ Weight Empty lb. (kg)	7.5 (3.41)	9.26 (4.2)
■ Weight Charged vapor lb. (kg)	10.2 (4.63)	13.01 (5.9)

MVE CryoCube™ & BL-7

Cat. No.	Model Number/Description	List Price
20902359	Cryocube Shipper	\$239.00
20860675	BL7 Cryocube	\$278.00

MVE Blood Bag Shippers

	CT-50	CT-250
Maximum Storage Capacity		
■ Number of Blood Bags	2 (25 mL)	2 (250 mL)
■ LN ₂ Capacity w/o Inventory L est.	5	8
■ Static Evaporation Rate* L/day	0.5	0.8
■ Static Holding Time* days	10	10
Unit Dimensions		
■ Neck Opening in. (mm)	3.82 (97)	6.5 (165)
■ Overall Height in. (mm)	15 (380)	19.8 (502)
■ Outer Diameter/Width in. (mm)	14.5 (368)	16.0 (406)
■ Weight Empty lb. (kg)	17.6 (8)	24.3 (11)
■ Weight Charged vapor lb. (kg)	26.45 (12)	38.6 (17.5)

MVE Blood Bag Shippers

Cat. No.	Model Number/Description	List Price
21007700	CT50 CryoShipper	\$1,147.00
21166073	CT50 Shipping Container with box	\$ 590.00
21116533	CT50 Standard Equipment Frame/ Cassette Puller (open ends)	\$ 38.00
21000341	CT250 CryoShipper	\$1,551.00
21000341	CT250 Shipping Container with box	\$ 633.00
21003575	CT250 Standard Equipment Frame/ Cassette Puller	\$ 40.00

Isothermal Cryogenic Dry-Vapor Freezers

- Engineered to maximize sample integrity
- Technology includes a LN₂ filled jacket that surrounds the chamber to provide completely dry storage and temperature consistency throughout the chamber
- Liquid-free chamber reduces chance of cross contamination
- No LN₂ in the chamber means minimal temperature decrease with lid open
- SmartTouch Controller features dual temperature display, autofill, alarm, fill timer, exportable reports, Modbus enabled, and programmable lid alarm
- 2 year parts, 5 year vacuum warranty

Cutting Edge Jacket Technology provides MORE space!



Isothermal Cryogenic Dry-Vapor Freezers

	V-1500AB	V-3000AB	V-5000AB	V-3000ABEH	V-5000ABEH	V-3000AB/C	V-5000AB/C	V-3000ABEH/C	V-5000ABEH/C
LN2 Capacity	30 Liters	70 Liters	93 Liters	89 Liters	140 Liters	70 Liters	93 Liters	89 Liters	140 Liters
Maximum Storage Capacity									
■ Vials (2 mL)	9,100	22,100	40,300	25,500	46,500	16,800	36,400	21,000	42,000
■ Cryobags (50 mL)	434	1,120	1,936	1,280	2,208	792	1,638	1,056	1,872
Unit Dimensions									
■ External Length mm (in.)	1005.8 (39.6)	1277.6 (50.3)	1450.3 (57.1)	1277.6 (50.3)	1450.3 (57.1)	1259.8 (49.6)	1445.3 (56.9)	1259.8 (49.6)	1445.3 (56.9)
■ External Width mm (in.)	675.6 (26.6)	955 (37.6)	1371.6 (54)	955 (37.6)	1371.6 (54)	970.3 (38.2)	1191.3 (46.9)	970.3 (38.2)	1191.3 (46.9)
■ Usable Interior Diameter mm (in.)	533.4 (21)	787.4 (31)	1016 (40)	787.4 (31)	1016 (40)	736.6 (29)	965.2 (38)	736.6 (29)	965.2 (38)
■ External Height mm (in.)	1211.6 (47.7)	1249.7 (49.2)	1430 (56.3)	1463 (57.6)	1551.9 (61.1)	1292.9 (50.9)	1475.7 (58.1)	1582.4 (62.3)	1602.7 (63.1)
■ Usable Interior Height mm (in.)	736.6 (29)	736.6 (29)	736.6 (29)	939.8 (37)	863.6 (34)	685.8 (27)	736.6 (29)	914.4 (36)	863.6 (34)
■ Liftover Height mm (in.)	1965.9 (77.4)	2278.4 (89.7)	2578.1 (101.5)	2491.7 (98.1)	2700 (106.3)	—	—	—	—

Dry Vapor Cryogenic Freezers

Isothermal Cryogenic Dry-Vapor Freezers

Cat. No.	Model Number/Description	List Price
V-Series Full Lip Opening		
55156V-ST	Model V-1500AB Isothermal Freezer, including Series 2301 SmartTouch Controller Autofill-Monitor System with Gas By-Pass System and LN ₂ Hose	\$22,687.94
55305V-ST	Model V-3000AB Isothermal Freezer, including Series 2301 SmartTouch Controller Autofill-Monitor System with Gas By-Pass System and LN ₂ Hose	\$41,063.34
55505V-ST	Model V-5000AB Isothermal Freezer, including Series 2301 SmartTouch Controller Autofill-Monitor System with Gas By-Pass System and LN ₂ Hose	\$48,146.86
55305VEH-ST	Model V-3000ABEH Isothermal Freezer, including Series 2301 SmartTouch Controller Autofill-Monitor System with Gas By-Pass System and LN ₂ Hose (Extended Height)	\$41,739.10
55505VEH-ST	Model V-5000ABEH Isothermal Freezer, including Series 2301 SmartTouch Controller Autofill-Monitor System with Gas By-Pass System and LN ₂ Hose (Extended Height)	\$49,861.55
V-Series Carousel Vapor Models		
77301C-ST	Model V-3000AB/C Isothermal Carousel Freezer, including Series 2301 ST (Smart-Touch Controller) Autofill-Monitor System with Gas By-Pass System, Carousel, Step and LN ₂ Hose	\$41,951.94
77501C-ST	Model V-5000AB/C Isothermal Carousel Freezer, including Series 2301 ST (Smart-Touch Controller) Autofill-Monitor System with Gas By-Pass System, Carousel, Step and LN ₂ Hose	\$50,066.97
77302CEH-ST	Model V-3000ABEH/C Isothermal Carousel Freezer, including Series 2301 ST (Smart-Touch Controller) Autofill-Monitor System with Gas By-Pass System, Carousel, Step and LN ₂ Hose (Extended Height)	\$43,342.15
77502CEH-ST	Model V-5000ABEH/C Isothermal Carousel Freezer Including Series 2301 ST (Smart-Touch Controller) Autofill-Monitor System with Gas By-Pass System, Carousel, Step and LN ₂ Hose (Extended Height)	\$51,251.77



Isothermal Carousel model with square lid

A wide lid opening allows easy access to all racks, and provides an extensive variety of inventory solutions.

Cryogenic Liquid Phase Freezers - Standard Series

- All S series freezers use the 2301 Controller with autofill functionality and dual temperature probes
- Flexibility for vapor storage, immersion storage, or a combination of both
- Round, space saving design
- Wide lid opening for easy access to racks
- Stainless steel, vacuum insulated vessel
- Woven lid gasket design and counter-balanced lockable lid
- Castor mounted
- Accommodates square, vertical and mini racks; canister and frame systems; vials, boxes, canisters / cassettes and platform dividers
- 2 year parts, 5 year vacuum warranty



Cryogenic Liquid Phase Freezers - Standard Series

	S-1500AB	S-3000AB	S-5000AB	S-5000ABEH
LN2 Capacity	145 Liters	345 Liters	615 Liters	720 Liters
Maximum Storage Capacity				
■ Vials (2 mL)	9,100	22,100	40,300	46,500
■ Blood Bags (50 mL)	434	1,120	720	2,208

Cryogenic Liquid Phase Freezers - Standard Series

Cat. No.	Model Number/Description	List Price
33156	Model S-1500AB, Standard LN ₂ Container, including 2301 Autofill-Monitor System with Gas By-Pass and LN ₂ Hose	\$16,433.83
33305	Model S-3000AB, Standard LN ₂ Container, including 2301 Autofill-Monitor System with Gas By-Pass and LN ₂ Hose	\$29,504.80
33505	Model S-5000AB, Standard LN ₂ Container, including 2301 Autofill-Monitor System with Gas By-Pass and LN ₂ Hose	\$35,511.52
33505BEH	Model S-5000ABEH, Standard LN ₂ Container, including 2301 Autofill-Monitor System with Gas By-Pass and LN ₂ Hose. (Extended Height)	\$36,904.60

Heathrow Cryogenic Vial Canes

Cat. No.	Description	List Price
HS23205	5-Place, Aluminum	\$ 43.60
HS23206	6-Place, Aluminum	\$ 43.60
HS23210	PVC Cryogenic Cane Sleeve, Clear	\$106.76

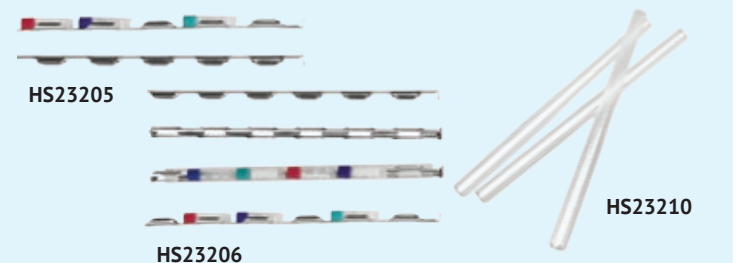

Model 2101

- Laptop controller using Windows based operating system
- Unlimited programming capability
- Multi-color graphing of sample, chamber and program temperature
- Temperature set points by sample or chamber
- Programs and freeze data saved to hard drive or disc
- Password protected software
- Searchable database for freeze run history
- Freeze run graphs and data available via any standard USB printer
- 30 data fields available for each freeze run
- Continuous digital and graph display for time and temperature during operation
- Manual overrides for all operating functions
- Temperature range +50°C to -180°C
- Freezing rates of 0.01° to 99.9° per minute
- Program temperature hold of 1 second to 99 hours
- Six pre-set easy to run freeze programs
- 1 year warranty



Controlled Rate Cryogenic Freezers (CRF) - Model 2101

Power Requirements

120 volt, 50/60 Hz, 10 amp or 230 volt, 50/60 Hz, 10 amp

Outside Dimensions

Depth	25 1/2" (648 mm) (including vent)
Height	29 1/4" (743 mm) (including computer)
Width	19 1/16" (484 mm) (including hose connection)

Inside Dimensions

Depth	9 9/16" (243 mm)
Height	13 3/4" (349 mm)
Width	14" (356 mm)

28 Liters

Controlled Rate Cryogenic Freezers (CRF) - Model 2101

Cat. No.	Model Number/Description	List Price
42100	Controlled Rate Freezing System, including Laptop Computer with 2101 Software with Freezing Chamber, Mobile Cart, 4 Foot LN ₂ Hose and Sample Freezing Rack and Single Probe	\$29,134.14
42101	Controlled Rate Freezing System, including Laptop Computer with 2101 Software, Freezing Chamber, 4 Foot LN ₂ Hose and Limited Choice of Sample Freezing Racks and Single Probe	\$27,677.44
3120-F601	Optional Roller Cart for 2101 Controlled Rate Freezing System	\$ 2,507.84
42100-EQ	Controlled Rate Freezing System, including Laptop Computer with 2101 Software with 2 Equine Freezing Profiles, Freezing Chamber, Mobile Cart, 4 Foot LN ₂ Hose and Sample Freezing Rack and Single Probe	\$29,134.14
42101-EQ	Controlled Rate Freezing System, including Laptop Computer with 2101 Software with 2 Equine Freezing Profiles, Freezing Chamber, Mobile Cart, 4 Foot LN ₂ Hose and Sample Freezing Rack and Single Probe	\$27,677.44
42100-MPI	Controlled Rate Freezing System, Multi-Probe, including Laptop Computer with 2101 Software, Freezing Chamber, Mobile Cart, 4 Foot LN ₂ Hose and Limited Choice of Sample Freezing Rack and Single Probe	\$34,275.46
42101-MPI	Controlled Rate Freezing System, Multi-Probe, including Laptop Computer with 2101 Software, Freezing Chamber, 4 Foot LN ₂ Hose and Limited Choice of Sample Freezing Rack and Single Probe	\$32,561.69

Model IntelliRate™ i67C

- Sized to scale precision rate freezing as your needs grow
- With 40% more capacity than other benchtop CRFs, the IntelliRate i67C can increase production levels, while ensuring more process consistency and time savings by running thousands of samples in a single run
- 1 year warranty

Model IntelliRate™ i67C Controlled Rate Freezers

Flexible Power Requirements

120-volt, 50/60 Hz, 10 amp or 240-volt, 50/60 Hz, 10 amp

More Freeze Capacity

67-liter (2.35 cu. ft.) volume inside the chamber delivers more batch capacity to freeze:

- 104 50mL bags • 2166 2mL vials • 100 cassettes
- 26 1-liter bags • 272 canes

Programming and Control Features

- Six preset programs with unlimited variations
- Repeatable temperature rate changes within cycles
- Programmable temperature range of -180°C to +50°C
- Freeze rates of 0.01 to 99.9°C per minute
- 21 CRF Part 11 compliant reporting protocols



INTERIOR VIEW
67-liter (2.35 cu. ft.)
volume inside the chamber

Model IntelliRate™ i67C Controlled Rate Freezers

Cat. No.	Model Number/Description	List Price
42101-67	The IntelliRate i67C Controlled Rate Freezer, 120V. Includes a built-in touchscreen controller with a stylist pen and 2101 Software with unlimited programming capability. Also included with the freezer are accessories including a 6-Foot LN2 Hose and a Single Probe for temperature monitoring in the chamber	\$36,380.00
42101-67-MPI	The IntelliRate i67C Controlled Rate Freezer, 120V. Includes a built-in touchscreen controller with a stylist pen and 2101 Software. Also included with the freezer are accessories including a 6-foot LN2 Hose and Multiple Probes for temperature monitoring throughout the chamber	\$40,660.00
42101-67-240V	The IntelliRate i67C Controlled Rate Freezer, 240V. Includes a built-in touchscreen controller with a stylist pen and 2101 Software with unlimited programming capability. Also included with the freezer are accessories including a 6-Foot LN2 Hose and a Single Probe for temperature monitoring in the chamber	\$36,380.00
42101-67-240V-MPI	The IntelliRate i67C Controlled Rate Freezer, 240V. Includes a built-in touchscreen controller with a stylist pen and 2101 Software. Also included with the freezer are accessories including a 6-foot LN2 Hose and Multiple Probes for temperature monitoring throughout the chamber	\$40,660.00

As cell-based research and bioproduction volumes increase, you need a repeatable freezing process that can efficiently improve post-thaw viability rates and cryopreservation quality at scale.

The IntelliRate™ i67C increases single-batch, liquid nitrogen (LN2) CRF capabilities to meet your needs as development and manufacturing volumes increase.

Value Added Cryosystems

- Lockable lids
- Low liquid nitrogen consumption
- Lightweight aluminum construction and low space demands
- Easy access to store or retrieve samples
- Square racks with boxes and dividers
- 3 year vacuum warranty
- Aluminum options: built in CRYO-LA, CRYO-BAT



Value Added Cryosystems		
Cat. No.	Model Number/Description	List Price
Series 2001 Value Added Cryosystem		
CB201	Cryosystem 2000 Rack, 5-Shelf, for 2-Inch High Boxes, Stainless Steel, with Locking Rod	\$6,481.91
CB201R	Cryosystem 2000 Rack, 5-Shelf, for 2-Inch High Boxes, Roller Base, Stainless Steel, with Locking Rod	\$6,788.08
CB201B	Cryosystem 2000 Rack, 5-Shelf, for 2-Inch High Boxes, Roller Base, Battery Alarm, Stainless Steel, with Locking Rod	\$7,658.31
CB201L	Cryosystem 2000 Rack, 5-Shelf, for 2-Inch High Boxes, Roller Base, 110v Alarm, Stainless Steel, with Locking Rod	\$7,764.50
Series 4001 Value Added Cryosystem		
CB401	Cryosystem 2000 Rack, 10-Shelf, for 2-Inch High Boxes, Stainless Steel, with Locking Rod	\$6,597.77
CB401R	Cryosystem 2000 Rack, 10-Shelf, for 2-Inch High Boxes, Roller Base, Stainless Steel, with Locking Rod	\$6,901.18
Series 6001 Value Added Cryosystem		
CB601	Cryosystem 2000 Rack, 10-Shelf, for 2-Inch High Boxes, Stainless Steel, with Locking Rod	\$7,178.37
CB601R	Cryosystem 2000 Rack, 10-Shelf, for 2-Inch High Boxes, Roller Base, Stainless Steel, with Locking Rod	\$7,512.13
CB601B	Cryosystem 2000 Rack, 10-Shelf, for 2-Inch High Boxes, Roller Base, Battery Alarm, Stainless Steel, with Locking Rod	\$8,383.74
CB601L	Cryosystem 2000 Rack, 10-Shelf, for 2-Inch High Boxes, Roller Base, 110v Alarm, Stainless Steel, with Locking Rod	\$8,494.07

Value Added Cryosystems			
	2001 Value Added	4001 Value Added	6001 Value Added
Storage Capacity			
■ Maximum number of racks	4	4	6
■ Maximum boxes per rack	5	10	10
■ Number of 1.2 and 2mL vials - 100/box	2,000	4,000	6,000
Liquid Nitrogen Usage and Capacities			
■ Liquid nitrogen capacity (liters)	61	121	175
■ Static evaporation rate (liters per day)	0.85	0.99	0.99
■ Working volume (liters)	51	111	165
■ Normal working days	38	70	104
Dimensions			
■ Neck opening in. (mm)	8.5 (216)	8.5 (216)	8.5 (216)
■ Overall height in. (mm)	28.5 (723)	39.5 (1,003)	39.5 (1,003)
■ Outside diameter in. (mm)	22 (559)	22 (559)	26 (665)
■ Weight empty lbs. (kgs)	58 (26.3)	81 (36.7)	103 (46.7)
■ Weight full lbs. (kgs)	182 (82.5)	300 (136)	425 (193)

Aluminum Canisters and Frames for Blood Bags

- Constructed of lightweight Aluminum
- Canisters hold Baxter Fenwal, Chartmed, Gambo, Stericon, Medsep, and Origen Blood Bags
- Canister sizes: 50mL, 250mL*
- Canisters have locking handle and thumb hole
- Canister frames include handles*
- Lifetime warranty for aluminum canisters and frames



C-50
50mL Blood Bag Canister

Aluminum Canisters and Frames for Blood Bags						
Cat. No.	Product Name	Blood Bag Number	Description	Dimensions in (mm)	Frame	List Price
C-50	50 mL Blood Bag Canister	Fenwal 4R9951, Origen CS50, CryoMACS 200-074-400, CharterMed CF-50, FP-50ML and FP-FLEX50	Holds most 50mL Blood Bags	6 5/16"D x 3 5/8"H x 1/2"L (160mmD x 92mmH x 11.8mmL)	F-C-50-7 F-C-50-8 F-C-50-9	\$36.25
C-250	250 mL Blood Bag Canister	Baxter Fenwal 4R9953, Origen CS250, CryoMACS 200-074-401, CharterMed CF-250, FP-250ML	Holds most 250mL Blood Bags	7 3/8"D x 5 7/8"H x 1/2"L x (191mmD x 152.5mmH x 11.8mmL)	F-C-250-3 F-C-250-4 F-C-250-5	\$36.25
Cat. No.	Product Name	Blood Bag Number	Description	Dimensions in (mm)	Canisters	List Price
F-C-50-7	7-High Frame for C-50	Fenwal 4R9951, Origen CS50, CryoMACS 200-074-400, CharterMed CF-50, FP-50ML, FP-FLEX50	Holds 7 C-50 Canisters	5 11/16"D x 26 1/16"H x 9/16"L (145mmD x 662mmH x 15mmL)	C-50	\$48.32
F-C-50-8	8-High Frame for C-50	Fenwal 4R9951, Origen CS50, CryoMACS 200-074-400, CharterMed CF-50, FP-50ML, FP-FLEX50	Holds 8 C-50 Canisters	5 11/16"D x 29 3/4"H x 9/16"L x (145mmD x 755mmH x 15mmL)	C-50	\$64.47
F-C-250-4	4-High Frame for C-250	Baxter Fenwal 4R9953, Origen CS250, CryoMACS 200-074-401, CharterMed CF-250, FP-250ML	Holds 4 C-250 Canisters	6 15/16"D x 24 15/16"H x 9/16"L x (176mmD x 633mmH x 15mmL)	C-250	\$53.17



F-C-50-7
7-High Frame For C-50

* Canister and Frames also available in 500mL, 750mL and 100mL — call for prices

Frames for Blood and Bone Marrow - LTI Inventory Control Systems

- Popular for plasma, cord blood and bone marrow storage
- Stainless steel frames are welded for superior durability
- Baxter 9955/9957 AKA 62/63, 2111 and canisters also available

Made in  the USA

Plasma System Frames						
Cat. No.			Dimensions H x W x T			List Price
61F-4SC	Baxter 9953 AKA 61	4 PLC	32.25"	6.5"	.60"	\$57.00
61F-5SC		5 PLC	26"	6.5"	.60"	\$60.00
61F-6SC		6 PLC	19.75"	6.5"	.60"	\$67.00
51F-6SC	Baxter 9951 AKA 51	6 PLC	25"	5.5"	.60"	\$59.00
51F-75C		7 PLC	29"	5.5"	.60"	\$62.00
51F-8SC		8 PLC	33"	5.5"	.60"	\$68.00
52F-6SC	Medsep AKA 52	6 PLC	23.25"	3 5/16"	.56"	\$58.00
52F-75C		7 PLC	27"	3 5/16"	.56"	\$61.00
52F-8SC		8 PLC	30.75"	3 5/16"	.56"	\$68.00

Liquid Nitrogen Freezer Rack with Locking Rod

Made in the USA 

- Corrosion resistant stainless steel
- All individual racks are shipped without boxes
- Boxes sold separately

Liquid Nitrogen Freezer Rack with Locking Rod			
Cat. No.	Capacity	Dimensions	List Price
Large Liquid Nitrogen Freezer Rack with Locking Rod			
SR 8-3	Holds (15) 2" Boxes	5.50" x 5.50" x 25.30"	\$126.51
SR 9-3	Holds (9) 3" Boxes	5.50" x 5.50" x 28.56"	\$115.44
SR 10-2	Holds (10) 2" Boxes	5.50" x 5.50" x 22.13"	\$109.98
SR 11-2	Holds (11) 2" Boxes	5.50" x 5.50" x 24.20"	\$111.72
SR 12-2	Holds (12) 2" Boxes	5.50" x 5.50" x 26.50"	\$123.56
SR 13-2	Holds (13) 2" Boxes	MOST POPULAR! 5.50" x 5.50" x 28.60"	\$130.58
SR 14-2	Holds (14) 2" Boxes	5.50" x 5.50" x 30.75"	\$142.84
SR 15-2	Holds (15) 2" Boxes	5.50" x 5.50" x 32.88"	\$155.65
Mini Liquid Nitrogen Freezer Rack with Locking Rod			
MR12-2-Mini	Holds (12) 2" Mini Plastic Boxes	3.38" x 3.15" x 26.50"	\$105.64
MR13-2-Mini	Holds (13) 2" Mini Plastic Boxes	3.38" x 3.15" x 28.60"	\$103.32
MR14-2 Mini	Holds (14) 2" Mini Plastic Boxes	3.38" x 3.15" x 30.75"	\$126.85
SR15-2-Mini	Holds (15) 2" Mini Plastic Boxes	3.38" x 3.15" x 32.88"	\$135.85



MTC Bio BetterBox™ Microtube Storage Boxes

- Organized, secure storage for 1.5mL tubes
- 81 slots to neatly and securely hold 1.5mL or 2.0mL microtubes
- Tube tray insert can be removed for crushed ice usage
- Autoclavable polypropylene
- Attached lid with a locking clasp

BetterBox™ Microtube Storage Boxes		
Cat. No.	Description	List Price
R1081-A	BetterBox™ Storage Boxes, 81-place for 1.5/2.0 mL Microtubes	\$42.27



Cryo-Gloves

Wrist Length, Water Proof, Breathable and Stay Dry Lining, 1 Pair					
	Small	Medium	Large	Extra-large	List Price
Blue	WRSWP	WRMWP	WRLWP	WRXLWP	\$223.36
Pink	P-RWS	P-RWM	P-RWL	P-RWXL	\$215.07
Mid-Arm Length, Water Proof, Breathable and Stay Dry Lining, 1 Pair					
	Small	Medium	Large	Extra-large	List Price
Blue	MAS	MAM	MAL	MAXL	\$283.44
Pink	P-MAS	P-MAM	P-MAL	P-MAXL	\$237.21
Elbow Length, Water Proof, Breathable and Stay Dry Lining, 1 Pair					
	Small	Medium	Large	Extra-large	List Price
Blue	EBSWP	EBMWP	EBLWP	EBXLWP	\$312.23
Pink	P-EBS	P-EBM	P-EBL	P-EBXL	\$298.21



Face and Eye Protection

Cat. No.	Description	List Price
PAT794	Protective Cryo Goggles	\$ 44.67
FSH1001	Cryo-Protection Face Shield Headgear with adjustable headband, clear large replaceable splash guard, adjustable pivots, clear window measures 10" x 10" x .060"	\$116.65



Cryo Aprons

Cat. No.	Description	List Price
CA36	Cryo-Apron, Water Proof, Splash Protection, Breathable, Quick Release Buckles at Neck and Waist, Maximum Thermal Protection, Light Weight and Comfortable, 36" Length	\$222.10
CA42	Cryo-Apron, Water Proof, Splash Protection, Breathable, Quick Release Buckles at Neck and Waist, Maximum Thermal Protection, Light Weight and Comfortable, 42" Length	\$234.03
CA48	Cryo-Apron, Water Proof, Splash Protection, Breathable, Quick Release Buckles at Neck and Waist, Maximum Thermal Protection, Light Weight and Comfortable, 48" Length	\$240.63
CA54	Cryo-Apron, Water Proof, Splash Protection, Breathable, Quick Release Buckles at Neck and Waist, Maximum Thermal Protection, Light Weight and Comfortable, 54" Length	\$265.31
10464394	Cryogenic Apron, Full Length	\$506.00



Cryo Tools

Cat. No.	Description	List Price
LMS-36	Measuring Stick, Liquid Level (Measures up to 36"/92 Centimeters)	\$ 25.95
C-4	Cryomarker - Set of 4 Pens (Black, Blue, Green & Red) Recommended for all Cryovials at -200°C	\$ 38.33
C-12	Cryomarker - Set of 12 Pens, One Color per Box (Specify Color - Black, Blue, Green or Red)	\$ 82.66
AR101	Sample Retrieval Device - Small (3" x 3")	\$390.56
AR102	Sample Retrieval Device - Large (6" x 6")	\$398.70
13051579	Cool Reach - Retrieval Tool - 40" (includes handle)	\$286.00

BIOX

Cryogenic Vials

BIOX Barcoded Cryovials 1D

- Clear polypropylene
- Sterile pre-set 1D barcoded with external thread and caps assembled
- Writing patch and marked graduations
- 25 cryovials/bag, 20 bags/pack, 2 packs/case, price/case/1000

BIOX Barcoded Cryovials 1D

Cat. No.	Description	List Price
BX88-6050	0.5mL Sterile Pre-set 1D Barcoded Cryovials, White Caps	\$240.40
BX88-6051	0.5mL Sterile Pre-set 1D Barcoded Cryovials, Red Caps	\$240.40
BX88-6052	0.5mL Sterile Pre-set 1D Barcoded Cryovials, Green Caps	\$240.40
BX88-6053	0.5mL Sterile Pre-set 1D Barcoded Cryovials, Blue Caps	\$240.40
BX88-6054	0.5mL Sterile Pre-set 1D Barcoded Cryovials, Yellow Caps	\$240.40
BX88-6055	0.5mL Sterile Pre-set 1D Barcoded Cryovials, Purple Caps	\$240.40
BX88-6100	1.0mL Sterile Pre-set 1D Barcoded Cryovials, White Caps	\$240.40
BX88-6101	1.0mL Sterile Pre-set 1D Barcoded Cryovials, Red Caps	\$240.40
BX88-6102	1.0mL Sterile Pre-set 1D Barcoded Cryovials, Green Caps	\$240.40
BX88-6103	1.0mL Sterile Pre-set 1D Barcoded Cryovials, Blue Caps	\$240.40
BX88-6104	1.0mL Sterile Pre-set 1D Barcoded Cryovials, Yellow Caps	\$240.40
BX88-6105	1.0mL Sterile Pre-set 1D Barcoded Cryovials, Purple Caps	\$240.40
BX88-6150	1.5mL Sterile Pre-set 1D Barcoded Cryovials, White Caps	\$240.40
BX88-6151	1.5mL Sterile Pre-set 1D Barcoded Cryovials, Red Caps	\$240.40
BX88-6152	1.5mL Sterile Pre-set 1D Barcoded Cryovials, Green Caps	\$240.40
BX88-6153	1.5mL Sterile Pre-set 1D Barcoded Cryovials, Blue Caps	\$240.40
BX88-6154	1.5mL Sterile Pre-set 1D Barcoded Cryovials, Yellow Caps	\$240.40
BX88-6155	1.5mL Sterile Pre-set 1D Barcoded Cryovials, Purple Caps	\$240.40

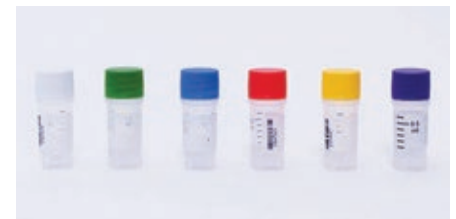

BX88-6050



BX88-6100



BX88-6150

BioX Tricode Cryovials 1D and 2D

- Clear polypropylene
- Sterile pre-set 1D and 2D barcoded with internal or external thread and caps assembled
- Writing patch and marked graduations
- 25 cryovials/bag, 20 bags/pack, 2 packs/case, price/case/1000

BioX Barcoded Cryovials 2D

Cat. No.	Description	List Price
BX88-9050	0.5mL Sterile Pre-set 2D Barcoded (Side & Bottom) Cryovials, White Caps	\$263.04
BX88-9051	0.5mL Sterile Pre-set 2D Barcoded (Side & Bottom) Cryovials, Red Caps	\$263.04
BX88-9052	0.5mL Sterile Pre-set 2D Barcoded (Side & Bottom) Cryovials, Green Caps	\$263.04
BX88-9053	0.5mL Sterile Pre-set 2D Barcoded (Side & Bottom) Cryovials, Blue Caps	\$263.04
BX88-9054	0.5mL Sterile Pre-set 2D Barcoded (Side & Bottom) Cryovials, Yellow Caps	\$263.04
BX88-9055	0.5mL Sterile Pre-set 2D Barcoded (Side & Bottom) Cryovials, Purple Caps	\$263.04

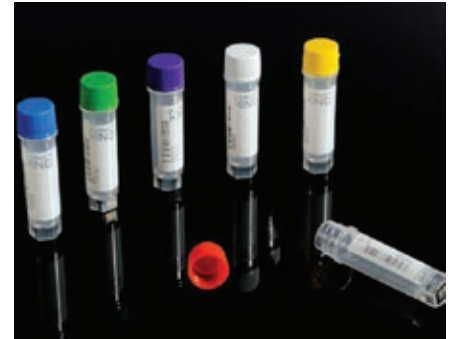

BX88-9050

BioX Tricode Barcoded Cryovials 1D and 2D

Cat. No.	Description	List Price
BX88-9100	1.0mL Sterile Pre-set 1D & 2D Barcoded Cryovials, EX Thread, White Caps	\$263.04
BX88-9101	1.0mL Sterile Pre-set 1D & 2D Barcoded Cryovials, EX Thread, Red Caps	\$263.04
BX88-9102	1.0mL Sterile Pre-set 1D & 2D Barcoded Cryovials, EX Thread, Green Caps	\$263.04
BX88-9103	1.0mL Sterile Pre-set 1D & 2D Barcoded Cryovials, EX Thread, Blue Caps	\$263.04
BX88-9104	1.0mL Sterile Pre-set 1D & 2D Barcoded Cryovials, EX Thread, Yellow Caps	\$263.04
BX88-9105	1.0mL Sterile Pre-set 1D & 2D Barcoded Cryovials, EX Thread, Purple Caps	\$263.04
BX88-9150	1.5mL Sterile Pre-set 1D & 2D Barcoded Cryovials, EX Thread, White Caps	\$263.04
BX88-9151	1.5mL Sterile Pre-set 1D & 2D Barcoded Cryovials, EX Thread, Red Caps	\$263.04
BX88-9152	1.5mL Sterile Pre-set 1D & 2D Barcoded Cryovials, EX Thread, Green Caps	\$263.04
BX88-9153	1.5mL Sterile Pre-set 1D & 2D Barcoded Cryovials, EX Thread, Blue Caps	\$263.04
BX88-9154	1.5mL Sterile Pre-set 1D & 2D Barcoded Cryovials, EX Thread, Yellow Caps	\$263.04
BX88-9155	1.5mL Sterile Pre-set 1D & 2D Barcoded Cryovials, EX Thread, Purple Caps	\$263.04
BX88-9200	2.0mL Sterile Pre-set 1D & 2D Barcoded Cryovials, EX Thread, White Caps	\$374.48
BX88-9201	2.0mL Sterile Pre-set 1D & 2D Barcoded Cryovials, EX Thread, Red Caps	\$374.48
BX88-9202	2.0mL Sterile Pre-set 1D & 2D Barcoded Cryovials, EX Thread, Green Caps	\$374.48
BX88-9203	2.0mL Sterile Pre-set 1D & 2D Barcoded Cryovials, EX Thread, Blue Caps	\$374.48
BX88-9204	2.0mL Sterile Pre-set 1D & 2D Barcoded Cryovials, EX Thread, Yellow Caps	\$374.48
BX88-9205	2.0mL Sterile Pre-set 1D & 2D Barcoded Cryovials, EX Thread, Purple Caps	\$374.48
BX88-9210	2.0mL Sterile Pre-set 1D & 2D Barcoded Cryovials, IN Thread, White Caps	\$402.20
BX88-9211	2.0mL Sterile Pre-set 1D & 2D Barcoded Cryovials, IN Thread, Red Caps	\$402.20
BX88-9212	2.0mL Sterile Pre-set 1D & 2D Barcoded Cryovials, IN Thread, Green Caps	\$402.20
BX88-9213	2.0mL Sterile Pre-set 1D & 2D Barcoded Cryovials, IN Thread, Blue Caps	\$402.20
BX88-9214	2.0mL Sterile Pre-set 1D & 2D Barcoded Cryovials, IN Thread, Yellow Caps	\$402.20
BX88-9215	2.0mL Sterile Pre-set 1D & 2D Barcoded Cryovials, IN Thread, Purple Caps	\$402.20
BX88-9500	5.0mL Sterile Pre-set 1D & 2D Barcoded Cryovials, EX Thread, White Caps	\$407.44
BX88-9501	5.0mL Sterile Pre-set 1D & 2D Barcoded Cryovials, EX Thread, Red Caps	\$407.44
BX88-9502	5.0mL Sterile Pre-set 1D & 2D Barcoded Cryovials, EX Thread, Green Caps	\$407.44
BX88-9503	5.0mL Sterile Pre-set 1D & 2D Barcoded Cryovials, EX Thread, Blue Caps	\$407.44
BX88-9504	5.0mL Sterile Pre-set 1D & 2D Barcoded Cryovials, EX Thread, Yellow Caps	\$407.44
BX88-9505	5.0mL Sterile Pre-set 1D & 2D Barcoded Cryovials, EX Thread, Purple Caps	\$407.44

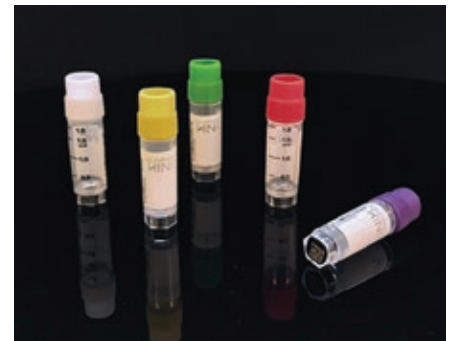

BX88-9200



BX88-9210



BX88-9500

BioX Pre-set Cryovials 1D

Cat. No.	Description	List Price
BX88-6200	2.0mL Sterile Pre-set 1D Barcoded Cryovials, EX Thread, White Caps	\$240.40
BX88-6201	2.0mL Sterile Pre-set 1D Barcoded Cryovials, EX Thread, Red Caps	\$240.40
BX88-6202	2.0mL Sterile Pre-set 1D Barcoded Cryovials, EX Thread, Green Caps	\$240.40
BX88-6203	2.0mL Sterile Pre-set 1D Barcoded Cryovials, EX Thread, Blue Caps	\$240.40
BX88-6204	2.0mL Sterile Pre-set 1D Barcoded Cryovials, EX Thread, Yellow Caps	\$240.40
BX88-6205	2.0mL Sterile Pre-set 1D Barcoded Cryovials, EX Thread, Purple Caps	\$240.40
BX88-6210	2.0mL Sterile Pre-set 1D Barcoded Cryovials, IN Thread, White Caps	\$270.72
BX88-6211	2.0mL Sterile Pre-set 1D Barcoded Cryovials, IN Thread, Red Caps	\$270.72
BX88-6212	2.0mL Sterile Pre-set 1D Barcoded Cryovials, IN Thread, Green Caps	\$270.72
BX88-6213	2.0mL Sterile Pre-set 1D Barcoded Cryovials, IN Thread, Blue Caps	\$270.72
BX88-6214	2.0mL Sterile Pre-set 1D Barcoded Cryovials, IN Thread, Yellow Caps	\$270.72
BX88-6215	2.0mL Sterile Pre-set 1D Barcoded Cryovials, IN Thread, Purple Caps	\$270.72
BX88-6500	5.0mL Sterile Pre-set 1D Barcoded Cryovials, EX Thread, White Caps	\$304.66
BX88-6501	5.0mL Sterile Pre-set 1D Barcoded Cryovials, EX Thread, Red Caps	\$304.66
BX88-6502	5.0mL Sterile Pre-set 1D Barcoded Cryovials, EX Thread, Green Caps	\$304.66
BX88-6503	5.0mL Sterile Pre-set 1D Barcoded Cryovials, EX Thread, Blue Caps	\$304.66
BX88-6504	5.0mL Sterile Pre-set 1D Barcoded Cryovials, EX Thread, Yellow Caps	\$304.66
BX88-6505	5.0mL Sterile Pre-set 1D Barcoded Cryovials, EX Thread, Purple Caps	\$304.66



BX88-6200



BX88-6210

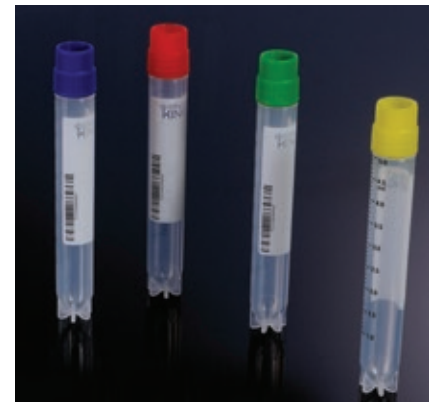

BX88-6500

BioX Tricode SBS Format Combo External Thread

- Screw top minitubes with caps
- Vials loaded into a barcoded 96-well rack
- Eternally threaded jacketed cryovials
- Feature 2D barcodes on bottom with matching 1D and human readable barcodes on the side
- 96 tubes/rack, 10 racks/case, price/case



BX89-8055



BX89-8205



BX89-5143

Tricode SBS Format Combo External Thread

Cat. No.	Description	List Price
BX89-8055	500µL SBS Format Screw Top Minitubes, Purple Caps, 960/case	\$685.92
BX89-8105	1.0mL SBS Format Screw Top Minitubes, Purple Caps, 960/case	\$750.60
BX89-8205	2.0mL SBS Format Screw Top Minitubes, Purple Caps, Loaded into a Barcoded 48-well Rack, 480/case	\$374.48
BX89-5143	1.4mL SBS Format Screw Top Minitubes, Blue Caps, Loaded into a Barcoded 48-well Rack, 960/case	\$750.60

BioDot Cryogenic Vials and Cap Inserts

- Certified RNase, DNase, Pyrogen and DNA free
- Store at temperatures as low as -196°C.
- Only for in the gas phase of liquid nitrogen
- Caps and tubes are made of polypropylene material
- Silicone seal fitted inside of cap ensures positive seal at any temperature
- Cap inserts available in different colors
- Super fast 1 1/4 turn thread design
- Thick wall makes vial almost unbreakable
- Large white marking area
- Excellent clarity makes sample easy to see
- Externally threaded round bottom vials can be centrifuged to 17,000g
- Internally threaded round bottom vials can be centrifuged to 14,000g
- Many sizes available as self-standing with universal locking base



T301-1



T301-5



T308-5A



T308-1

Cat. No.	Description	List Price
Sterile Internal Thread with Silicone O-ring Seal		
T301-1	Cryogenic Vial with Silicone O-Ring Seal, 1.2mL, 12.5 x 41mm, Self Standing, Internal Thread, Polypropylene, Marking Area, 1000 Per Case	\$399.19
T301-2	Cryogenic Vial with Silicone O-Ring Seal, 2.0mL, 12.5 x 49mm, Self Standing, Internal Thread, Polypropylene, Marking Area, 1000 Per Case	\$396.88
T301-3	Cryogenic Vial with Silicone O-Ring Seal, 2.0mL, 12.5 x 48mm, Round Bottom, Internal Thread, Polypropylene, Marking Area, 1000 Per Case	\$396.96
T301-4	Cryogenic Vial with Silicone O-Ring Seal, 2.0mL, 12.5 x 70mm, Round Bottom, Internal Thread, Polypropylene, Marking Area, 1000 Per Case	\$446.28
T301-4A	Cryogenic Vial with Silicone O-Ring Seal, 2.0mL, 12.5 x 72mm, Self-Standing, Internal Thread, Polypropylene, Marking Area, 1000 Per Case	\$446.28
T301-5	Cryogenic Vial with Silicone O-Ring Seal, 5mL 12.5 x 90mm, Round Bottom, Internal Thread, Polypropylene, White Marking Area, 1000 Per Case	\$540.84
Sterile External Thread with Lip Seal + O-ring Seal		
T308-1A	Cryogenic Vial with Lip and Silicone Washer Seal, 1.2mL, 12.5 x 42mm, Self-Standing, External Thread, Polypropylene, Marking Area, 1000 Per Case	\$422.47
T308-2	Cryogenic Vial with Lip and Silicone Washer Seal, 2.0mL, 12.5 x 47mm, Round Bottom, External Thread, Polypropylene, Marking Area, 1000 Per Case	\$422.47
T308-2A	Cryogenic Vial with Lip and Silicone Washer Seal, 2.0mL, 12.5 x 49mm, Self-Standing, External Thread, Polypropylene, Marking Area, 1000 Per Case	\$422.47
T308-3A	Cryogenic Vial with Lip and Silicone Washer Seal, 3.0mL, 12.5 x 71mm, Self-Standing, External Thread, Polypropylene, Marking Area, 1000 Per Case	\$443.54
T308-4A	Cryogenic Vial with Lip and Silicone Washer Seal, 4.0mL, 12.5 x 77mm, Self-Standing, External Thread, Polypropylene, Marking Area, 1000 Per Case	\$481.98
T308-5A	Cryogenic Vial with Lip and Silicone Washer Seal, 5.0ml, 12.5 x 91mm, Self-Standing, External Thread, Polypropylene, Marking Area, 1000 Per Case	\$535.62

Did you know LabMart can provide text or matching 1D/2D barcoded vials? We can help your lab's tracking and on-demand needs with our IDs. Permanent custom barcoding is also available. 100% quality control ensures that all high-quality standards are met!

**Need help identifying your requirements?
Call us today for assistance.**

Cryogenic Vials, Inserts and Closures

Cat. No.	Description	List Price
Sterile External Thread with Lip Seal		
T309-1A	Cryogenic Vial with Lip Seal, 1.2mL, 12.5 x 42mm, Self-Standing, External Thread, Polypropylene, Marking Area, 1000 Per Case	\$314.57
T309-2	Cryogenic Vial with Lip Seal, 2.0mL, 12.5 x 47mm, Round Bottom, External Thread, Polypropylene, Marking Area, 1000 Per Case	\$314.57
T309-2A	Cryogenic Vial with Lip Seal, 2.0mL, 12.5 x 47mm, Self-Standing, External Thread, Polypropylene, Marking Area, 1000 Per Case	\$314.57
T309-3A	Cryogenic Vial with Lip Seal, 3.0mL, 12.5 x 71mm, Self-Standing, External Thread, Polypropylene, Marking Area, 1000 Per Case	\$327.70
T309-4A	Cryogenic Vial with Lip Seal, 4.0mL, 12.5 x 77mm, Self-Standing, External Thread, Polypropylene, Marking Area, 1000 Per Case	\$351.11
T309-5A	Cryogenic Vial with Lip Seal, 5.0mL, 12.5 x 91mm, Self-Standing, External Thread, Polypropylene, Marking Area, 1000 Per Case	\$395.02
Sterile External Thread with Silicone Washer Seal		
T310-10A	External Threaded Cryogenic Vial with Polyethylene Cap with Silicone Washer Seal, Natural, Sterile, Self-Standing, 10mL, 50 per Bag	\$ 34.19
T310-1A	External Threaded Cryogenic Vial with Silicone Washer Cap, Natural, Sterile, Self Standing, 1.2mL, 100 per Bag	\$ 40.81
T310-2	External Threaded Cryogenic Vial with Silicone Washer Cap, Natural, Sterile, Round Bottom, 2.0mL, 100 per Bag	\$ 40.81
T310-2A	External Threaded Cryogenic Vial with Silicone Washer Cap, Natural, Sterile, Self Standing, 2.0mL, 100 per Bag	\$ 40.81
T310-3A	External Threaded Cryogenic Vial with Silicone Washer Cap, Natural, Sterile, Self Standing, 3.0mL, 100 per Bag	\$ 41.40
T310-4A	External Threaded Cryogenic Vial with Silicone Washer Cap, Natural, Sterile, Self Standing, 4.0mL, 100 per Bag	\$ 45.61
T310-5A	External Threaded Cryogenic Vial with Silicone Washer Cap, Natural, Sterile, Self Standing, 5mL, 100 per Bag	\$ 49.82
Sterile Internal Thread with Silicone Washer Seal		
T311-1	Internal Threaded Cryogenic Vial with Silicone Washer Cap, Natural, Sterile, Self Standing, 1.2mL, 100 per Bag	\$ 39.48
T311-2	Internal Threaded Cryogenic Vial with Silicone Washer Cap, Natural, Sterile, Self Standing, 2.0mL, 100 per Bag	\$ 39.65
T311-3	Internal Threaded Cryogenic Vial with Silicone Washer Cap, Natural, Sterile, Round Bottom, 2.0mL, 100 per Bag	\$ 39.65
T311-4	Internal Threaded Cryogenic Vial with Silicone Washer Cap, Natural, Sterile, Round Bottom, 4.0mL, 100 per Bag	\$ 46.00
T311-4A	Internal Threaded Cryogenic Vial with Silicone Washer Cap, Natural, Sterile, Self Standing, 4.0mL, 100 per Bag.	\$ 46.00
T311-5	Internal Threaded Cryogenic Vial with Silicone Washer Cap, Natural, Sterile, Round Bottom, 5mL, 100 per Bag	\$ 53.75
Color-coded Cap Inserts		
T312-1	Color Coded Cap Inserts, White, 500 per Bag	\$ 20.37
T312-2	Color Coded Cap Inserts, Blue, 500 per Bag	\$ 20.37
T312-3	Color Coded Cap Inserts, Red, 500 per Bag	\$ 20.37
T312-4	Color Coded Cap Inserts, Green, 500 per Bag	\$ 20.37
T311-5	Color Coded Cap Inserts, Yellow, 500 per Bag	\$ 20.37
T312-7	Color Coded Cap Inserts, Assorted, 500 per Bag	\$ 20.37
T312-8	Color Coded Cap Inserts, Tan, 500 per Bag	\$ 20.37
T312-9	Color Coded Cap Inserts, Gray, 500 per Bag	\$ 20.37
T312-10	Color Coded Cap Inserts, Lilac, 500 per Bag	\$ 20.37
T312-11	Color Coded Cap Inserts, Burnt Orange, 500 per Bag	\$ 20.37
T312-13	Color Coded Cap Inserts, Purple, 500 per Bag	\$ 20.37
T312-14	Color Coded Cap Inserts, Pink, 500 per Bag	\$ 20.37



T309-1



T309-5A



T310-5A



T310-1



T311-1



T311-5

Cryogenic Freezer and Storage Boxes

BioX Polycarbonate Freezer Box with Removable Lid

- Numeric grid for identification purposes
- Assorted colors: red, yellow, green, blue and white

BioX Polycarbonate Freezer Box with Removable Lid		
Cat. No.	Description	List Price
BX90-9009-1	2" 81-Well PC Freezer Boxes with Lids, (132 x 132 x 53mm), 20/case	\$203.90
BX90-9210-1	2" 100-Well PC Freezer Boxes with Lids, (132 x 132 x 53mm), 20/case	\$203.90
BX90-9381	3.75" 81-Well PC Freezer Boxes with Lids, (132 x 132 x 53mm), 20/case	\$203.90
BX90-9250-1	2" 25-Well PC Freezer Boxes with Lids, (75 x 75 x 52mm), 30/case	\$203.90

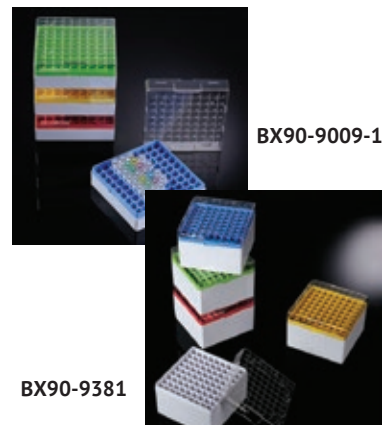

BioX Autoclavable Polycarbonate Cryogenic Boxes

- 100-well blue polycarbonate scan-ready
- Autoclavable cryogenic storage box
- 133 x 133x 36mm
- Marked numeric grid for identification purposes
- 6 boxes/pack, 2 packs/case, price/case/12

BioX Autoclavable Polycarbonate Cryogenic Boxes		
Cat. No.	Description	List Price
BX98-0113	1" 100-Well PC Scan-Ready Autoclavable Cryogenic Box, Blue	\$122.94
BX98-0213	2" 100-Well PC Scan-Ready Autoclavable Cryogenic Box, Blue	\$122.94

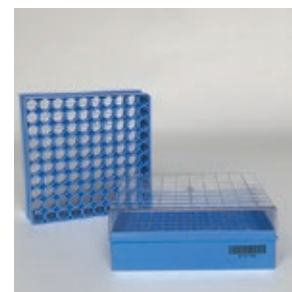

CryoSette™ Frozen Tissue Storage Boxes and Accessories

Cat. No.	Description	List Price
M956-21W	CryoSette™ Frozen Tissue Storage Boxes, Designed to Contain 21 Frozen Tissue CryoSette Containers, Polypropylene, Suitable for Cryogenic Storage	\$165.40
M956-40B	Cryosette Frozen Tissue Storage Box, 40 Place, Polycarbonate, Frosted Cover, Temperature Range -196°C to 121°C, Autoclavable, 133 x 133 x 52mm (H), Suitable only in Gas Phase LN2, 10 Storage Boxes Per Case	\$175.09
M956COV	CryoSette Transparent Plastic ID Label Cover for M956O CryoSette Frozen Tissue Container, 100 per Pack	\$ 40.00
M956LAB	Cardboard ID Label for CryoSette M956O, 100 Per Pack	\$115.85
M956O	CryoSette Frozen Tissue Storage Container, Orange and White, Base is Acetal, Screw Closure is High-density Polyethylene, Offers Sample Specimen Storage in Upright Chest Freezers and Vapor-Phase Dewar Flasks at -196°C but not in LN2 Liquid Phase, Chamber Dimensions 21mm O.D. x 18mm ID x 10.5mm H, Total CryoSette Dimensions: 24 mm x 38 mm x 11 mm H., 95 kPa Tested, 250 Per Case	\$553.50
M956SEP	Cardboard Separator for M956-40B CryoSette 40 Place Storage Box, 6 Per Case	\$ 22.50
M957B	Cap Insert for CryoSette, Blue, Polypropylene, 5.3mm in Diameter, 500 Per Case	\$ 41.98
M957G	Cap Insert for CryoSette, Green, Polypropylene, 5.3mm in Diameter, 500 Per Case	\$ 41.98
M957L	Cap Insert for CryoSette, Lilac, Polypropylene, 5.3mm in Diameter, 500 Per Case	\$ 41.98
M957R	Cap Insert for CryoSette, Red, Polypropylene, 5.3mm in Diameter, 500 Per Case	\$ 41.98
M957Y	Cap Insert for CryoSette, Yellow, Polypropylene, 5.3mm in Diameter, 500 Per Case	\$ 41.98

Polycarbonate and Polypropylene Freezer Boxes

Cryostore™ Autoclavable Polycarbonat e Cryogenic Boxes

- Designed to be used at temperatures between -196°C and +121°C
- Autoclavable at 120°C, 15 psig (1 bar) for 20 minutes
- A transparent cover to see contents, and keyed to the base to prevent misalignment
- Printed with a series of squares



Cryostore™ Autoclavable Polycarbonate Cryogenic Boxes		
Cat. No.	Description	List Price
T314-2100B	Cryovial Plastic Storage Boxes, 1.2mL and 2mL, 100 Place, Blue	\$11.84
T314-2100G	Cryovial Plastic Storage Boxes, 1.2mL and 2mL, 100 Place, Green	\$11.84
T314-2100R	Cryovial Plastic Storage Boxes, 1.2mL and 2mL, 100 Place, Red	\$11.84
T314-2100Y	Cryovial Plastic Storage Boxes, 1.2mL and 2mL, 100 Place, Yellow	\$11.84

Cryostore™ Polycarbonate Cryovial 81-Well Storage Boxes

- Holds 81 cryogenic vials of 1mL to 2 mL sizes
- Made of polycarbonate, resistant to temperatures between -196°C and 121°C
- Transparent cover with printed numerical grid from 1 to 81
- Comes in four different colored grids (blue, green, red and yellow)
- Stackable with drain holes on the base and vent holes on the lids
- Vial picker included with every box



Cryostore™ Polycarbonate Cryovial 81-Well Storage Boxes		
Cat. No.	Description	List Price
T314-281B	Cryogenic 81-Well Storage Boxes for 1.2mL to 2.0mL Vials, Blue, 5.25" x 5.25" x 2.06"	\$11.40
T314-281G	Cryogenic 81-Well Storage Boxes for 1.2mL to 2.0mL Vials, Green, 5.25" x 5.25" x 2.06"	\$11.40
T314-281R	Cryogenic 81-Well Storage Boxes for 1.2mL to 2.0mL Vials, Red, 5.25" x 5.25" x 2.06"	\$11.40
T314-281Y	Cryogenic 81-Well Storage Boxes for 1.2mL to 2.0mL Vials, Yellow, 5.25" x 5.25" x 2.5"	\$11.40

BiOX Polypropylene Freezer Boxes with Removable Lids

- Numeric grid for identification purposes
- Assorted colors (clear, pink, blue, green and yellow)



BX90-9025-1

BiOX Polypropylene Freezer Boxes with Removable Lids		
Cat. No.	Description	List Price
BX90-9081	2" 81-Well Polypropylene Freezer Box, 132 x 132 x 53mm, 20/case	\$ 80.60
BX90-9100	2" 100-Well Polypropylene Freezer Box, 141 x 153.7 x 54.6mm, 20/case	\$106.80
BX90-9200	2" 100-Well Polypropylene Freezer Box, 132 x 132 x 53mm, 20/case	\$106.80
BX90-9025-1	2" 25-Well Polypropylene Freezer Box, 75 x 75 x 52mm, 30/case	\$ 80.60



BX90-9100

Cardboard Freezer Boxes

BioX Cardboard Freezer Boxes

Cat. No.	Description	List Price
Superior White Cardboard Freezer Boxes		
BX90-1281	2" 81-well Cardboard Freezer Boxes, 5 boxes/pack, 20 packs/case, price/case/100	\$256.36
BX90-1200	2" 100-well Cardboard Freezer Boxes, 5 boxes/pack, 20 packs/case, price/case/100	\$256.36
BX90-1381	3" 81-well Cardboard Freezer Boxes, 5 boxes/pack, 20 packs/case, price/case/100	\$312.76
BX90-1300	3" 100-well Cardboard Freezer Boxes, 5 boxes/pack, 20 packs/case, price/case/100	\$312.76
White Plasti-Coat™ Cardboard Freezer Boxes		
BX90-2281	2" 81-well Cardboard Freezer Boxes, 5 boxes/pack, 20 packs/case, price/case/100	\$221.02
BX90-2200	2" 100-well Cardboard Freezer Boxes, 5 boxes/pack, 20 packs/case, price/case/100	\$221.02
BX90-2381	3" 81-well Cardboard Freezer Boxes, 5 boxes/pack, 20 packs/case, price/case/100	\$221.02
BX90-2300	3" 100-well Cardboard Freezer Boxes, 5 boxes/pack, 20 packs/case, price/case/100	\$221.02
Cryo-Color™ Cardboard Freezer Boxes - Assorted Colors (Red, Blue, Green, Yellow & White)		
BX90-5281	2" 81-well Cardboard Freezer Boxes, 5 boxes/pack, 20 packs/case, price/case/100	\$300.82
BX90-5200	2" 100-well Cardboard Freezer Boxes, 5 boxes/pack, 20 packs/case, price/case/100	\$300.82
BX90-1536	5" 36-well Cardboard Freezer Boxes (for 1.5mL Tubes), 5 boxes/pack, 20 packs/case, price/case/100	\$433.12
BX90-5016	5" 16-well Cardboard Freezer Boxes (for 5.0mL Tubes), 5 boxes/pack, 20 packs/case, price/case/100	\$433.12
Water Resistant ID-Color™ Cardboard Freezer Boxes - Hinged Lid and Divider Made of PP Material, Marked Alphanumeric Grid for Identification, Assorted Colors (Red, Blue, Green, Yellow and White)		
BX90-8100	1" 100-well Water Resistant Cardboard Freezer Boxes, 5 boxes/pack, 4 packs/case, price/case/20	\$106.09
BX90-8200	1" 81-well Water Resistant Cardboard Freezer Boxes, 5 boxes/pack, 4 packs/case, price/case/20	\$106.09
BX90-8281	2" 100-well Water Resistant Cardboard Freezer Boxes, 5 boxes/pack, 4 packs/case, price/case/20	\$106.09
BX90-8381	3" 81-well Water Resistant Cardboard Freezer Boxes, 5 boxes/pack, 4 packs/case, price/case/20	\$106.09



BX90-1281

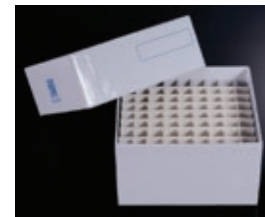

BX90-1381



BX90-2200



BX90-2300



BX90-5016

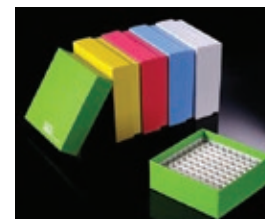

BX90-5281

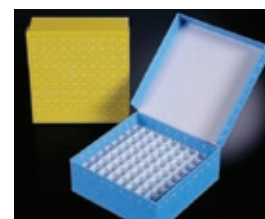

BX90-8200

2" Cardboard Cryovial Storage Boxes with Dividers

- 81 or 100 cell dividers
- Small holes or slots on bottom provides safe drainage of liquid nitrogen or prevents moisture build-up
- For use with LN2 or mechanical freezers
- Durable white wax coated inside and out
- 5.25" x 5.25" x 2"

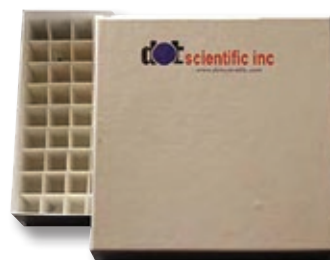

2" Cardboard Cryovial Storage Boxes with Dividers

Cat. No.	Description	List Price
202081	81 Cell, Wax Coated	\$5.35
202100	100 Cell, Wax Coated	\$5.35

Get Instant Rebates on Energy-Efficient Lab Cold Storage Equipment!

Did you know that some electric utility companies have programs that offer rebates for making energy-efficient lab grade cold storage choices? Laboratories in select areas can receive up to \$1,200 toward each purchase of an ENERGY STAR® Certified High Performance Laboratory Grade Refrigerator or Freezer, and up to \$2,000 toward each purchase of an ENERGY STAR® Certified Ultra-Low Temperature (ULT) Freezer! These Instant Rebates are applied right to your quote or invoice as a discount at time of purchase, without the need for any complicated paperwork or a long wait for reimbursement.

Ask your LabMart representative about available incentives in your area and be sure to look for these starbursts throughout this catalog for Instant Rebates-eligible products.

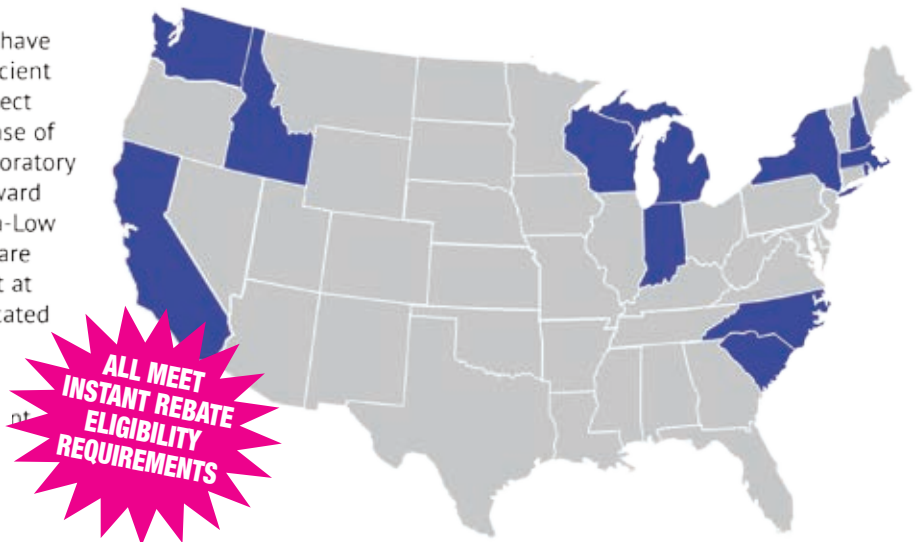

Program	Geography	Measures	Rebate
California Energy Wise	CA	ULT Freezers	\$600-900
Mass Save NH Saves Rhode Island Energy	MA, NH, RI	ULT Freezers, HP Lab Grade Freezers, HP Lab Grade Refrigerators	\$600-2000
DTE	MI (Metro Detroit)	ULT Freezers, HP Lab Grade Freezers, HP Lab Grade Refrigerators	\$600-1200
Duke Energy	NC, SC, IN	ULT Freezers	\$400
New York (NYSEG-RGE)	NY	ULT Freezers, HP Lab Grade Freezers, HP Lab Grade Refrigerators	\$600-1200
PNW (Puget Sound Energy, Seattle City Light)	WA (Greater Seattle)	ULT Freezers, HP Lab Grade Freezers*, HP Lab Grade Refrigerators* <i>*Seattle Only</i>	\$600-1200
Avista	Eastern WA, ID (Panhandle)	ULT Freezers	\$1,200
Wisconsin Focus on Energy	WI	ULT Freezers, HP Lab Grade Freezers, HP Lab Grade Refrigerators	\$600-1200



Dot Scientific is a participating distributor in the utility-sponsored energy efficient ultra-low temperature freezers rebate programs nationwide. We can help you save money at the time of purchase, and lower energy usage will help lower your electric bills over the lifetime of your freezer.



About Energy Solutions

Energy Solutions is a mission-driven clean energy implementation firm that specializes in programs that align with the market to deliver significant energy, carbon, and water-use savings. For 25 years we've been pioneering end-to-end, market-driven solutions that deliver reliable, large-scale and cost-effective savings to our utility, government, and private sector clients across North America. Our passionate, smart employee-owners are committed to excellence and to building long-lasting, trusted relationships with our clients.

Combination Freezers/Refrigerators

Haier Upright Combined Freezer and Refrigerator

- Designed to store frozen plasma, biomaterials, vaccines, electronic devices
- Also for low temperature storage of special materials, in blood banks, hospitals, clinics, universities, and other laboratories
- Microprocessor controller with digital display
- Multipurpose and space efficient, stainless steel interior
- Refrigerator temperature range: 2 to 8°C, forced air cooling and auto defrost
- Freezer temperature range -15 to -40°C, direct cooling and manual defrost
- Separate doors with independent latches
- Hydrocarbon refrigerant (R600A for refrigerator, R290 for freezer)
- LED display, multiple alarms, remote alarm, two types of alarm indications: audible buzzer and visible flashing light
- USB port, casters and two leveling legs
- Exterior dimensions (W x D x H): 28.9" x 26.0" x 71.3", 115V, 60Hz



Haier Upright Combined Freezer and Refrigerator

Cat. No.	Description	List Price
HYCD-319A	Combined Freezer and Refrigerator, Refrigerator: 200L (7.06 cu. ft.), 3 adjustable shelves. Freezer: 100L (3.53 cu. ft.), 115v/60Hz, 1 fixed shelf	\$5,100.00

Haier Upright Combined Freezer and Refrigerator

- Designed to store frozen plasma, biomaterials, vaccines, electronic devices
- Also for low temperature storage of special materials, in blood banks, hospitals, clinics, universities, and other laboratories
- Refrigerator: 8.85 cu. ft. (245L), three adjustable shelves, temperature range: 2 to 8°C, forced air cooling and auto defrost, refrigerant R600A
- Freezer is 7.1 cu. ft. (200L), three fixed shelves, temperature range -10 to -40°C, direct cooling and manual defrost, refrigerant R290
- Microprocessor controller, separate doors with independent latches
- LED display, multiple alarms, remote alarm, two types of alarm indications: audible buzzer and visible flashing light
- USB port, casters and two leveling legs
- Exterior dimensions (W x D x H): 29.1" x 32.8" x 77.8", 115V, 60Hz



Haier Upright Combined Freezer and Refrigerator

Cat. No.	Description	List Price
HYCD-469A	Combined Freezer and Refrigerator, 115v/60Hz, Refrigerator: 8.85 cu ft. (245L). 3 adjustable shelves. Freezer: 7.1 cu. ft. (200L), 3 fixed shelves,	\$6,000.00

ABS General Purpose Dual Temperature Refrigerator and Freezer

- Standard analog dial temperature thermostats
- Auto defrost freezer compartments have programmed defrost cycles that will reach air temperatures of approximately 0°C
- Environmentally friendly, natural hydrocarbon (HC) refrigerants vastly reduce global-warming potential (GWP) while meeting new EPA/SNAP mandates and UL,ASHRAE compliance guidelines







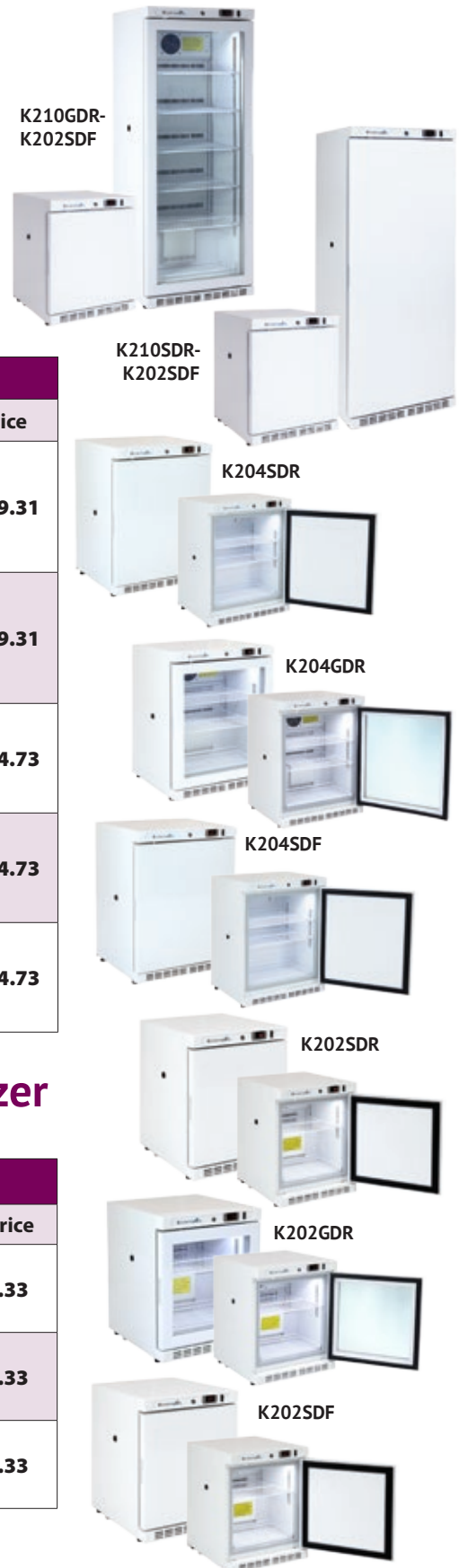

ABS General Purpose Dual Temperature Refrigerator and Freezer

Cat. No.	Description	
ABT-HC-RFC20A	Combination Lab Refrigerator/Freezer, 20 cu. ft.	Call for Pricing

K2 Scientific Under Counter and Benchtop Refrigerators



- All K2 Scientific under counter and benchtop units are stackable and all K202 units are able to stack on top of all K210 units
- Intelligent microprocessor controller with digital display and adjustable temperature control, static defrost on refrigerators, audible and visual high or low temperature alarms, magnetically sealed door with rapid cool-down mode after door opening, keyed door lock
- White epoxy-coated wire shelves, adjustable by 1" increments, gforced air circulation aids temperature stability and uniformity, remote alarm contacts, 0.50" temperature probe and data logger access port
- Two-year parts, labor or full replacement warranty
- cULus, ISO 9001:2015, Energy Star, CDC and VFC Compliant, EPA and SNAP compliant



K2 Scientific Under Counter and Benchtop Refrigerators		
Cat. No.	Description	List Price
K210GDR-K202SDF 	Life Science Performance Refrigerator: 10 cu. ft., Exterior Dimensions (WxDxH): 23.6" x 22.5" x 60.2", Temperature Range 2°C to 8°C, Glass Door, 6 Shelves. Freezer: 2.5 cu. ft., Exterior Dimensions (WxDxH): 20.1" x 22.5" x 25.75", Temperature Range -10°C to -25°C, Solid Door, 2 Shelves	\$3,119.31
K210SDR-K202SDF 	Life Science Performance Refrigerator: 10 cu. ft., Exterior Dimensions (WxDxH): 23.6" x 22.5" x 60.2", Temperature Range 2°C to 8°C, Solid Door, 6 Shelves. Freezer: 2.5 cu. ft., Exterior Dimensions (WxDxH): 20.1" x 22.5" x 25.75", Temperature Range -10°C to -25°C, Solid Door, 2 Shelves	\$3,119.31
K204SDR 	Life Science Performance Under Counter Solid Door Refrigerator, 4 cu. ft., Exterior Dimensions (WxDxH): 23.75" x 22.5" x 31.8", Temperature Range 2°C to 8°C, 3 Shelves.. Can be used on the bench, underneath or stacked.	\$1,214.73
K204GDR 	Life Science Performance Under Counter Glass Door Refrigerator, 4 cu. ft., Exterior Dimensions (WxDxH): 23.75" x 22.5" x 31.8", Temperature Range 2°C to 8°C, 3 Shelves. Can be used on the bench, underneath or stacked.	\$1,214.73
K204SDF 	Life Science Performance Under Counter Solid Door Freezer, 4 cu. ft., Exterior Dimensions (WxDxH): 23.75" x 22.5" x 31.8", Temperature Range -10°C to -25°C, Manual Defrost. Can be used on the bench, underneath or stacked.	\$1,214.73

K2 Scientific Benchtop Refrigerator and Freezer

- Refer to specifications above

K2 Scientific Benchtop Refrigerator and Freezer		
Cat. No.	Description	List Price
K202SDR 	Life Science Performance Benchtop Refrigerator, Exterior Dimensions (WxDxH): 20.1" x 22.5" x 25.75", Temperature Range 2°C to 8°C, 2 Shelves, Solid Door, 2.5 cu. ft.	\$981.33
K202GDR 	Life Science Performance Benchtop Refrigerator, Exterior Dimensions (WxDxH): 20.1" x 22.5" x 25.75", Temperature Range 2°C to 8°C, 2 Shelves, Glass Door, 2.5 cu. ft.	\$981.33
K202SDF 	Life Science Performance Benchtop Freezer: Exterior Dimensions (WxDxH): 20.1" x 22.5" x 25.75", Temperature Range -10°C to -25°C, Solid Door, 2 Shelves, Manual Defrost, 2.5 cu. ft.	\$981.33

*Under 6 cu. ft. do not qualify for Instant Rebates even if Energy Star rated.

Combination Freezers/Refrigerators

ABS General Purpose Combination Refrigerator with Freezer

- Refrigerator: Capacity: 3 cu. ft., Temperature range: 0°C to 10°C (32°F to 50°F)
- Freezer: Capacity: 3 cu. ft., Temperature range: -8°C to -21°C
- Manual defrost
- Exterior dimensions (H x W x D): 33.75" x 19" x 19.5"



ABS General Purpose Combination Refrigerator with Freezer

Cat. No.	Description	
ABT-RFC-3M	Lab Refrigerator/Freezer Combo, Solid Door, Manual GP 3 cu. ft.	Call for Pricing

Freestanding Under Counter Lab Refrigerators

ABS Premier Freestanding Under Counter 2.5 cu. ft. Refrigerator

- Digital temperature display with adjustable operating range: 1°C to 10°C
- Microprocessor temperature controller; audible and visual high and low temperature
- Back wall evaporator cover, cycle defrost, forced draft circulation
- Keyed door lock, four adjustable shelves, magnetic door gasket for positive seal, remote alarm contacts, 0.375" probe access port, powder-coated exterior, leveling legs, HFC-free refrigerant (R600a), foam insulation and packaging, 1/8 HP Compressor, 0.90 amps, Energy Star certified
- Exterior dimensions (W x D x H): 17.75" x 19.50" x 29.875"
- Two year parts and labor warranty, plus an additional three year compressor parts only warranty
- Note: This unit must have a 4" clearance on sides and back for adequate ventilation





ABT-HC-UCFS-0204



ABT-HC-UCFS-0204G

ABS Premier Freestanding Under Counter 2.5 cu. ft. Refrigerator

Cat. No.	Description	
ABT-HC-UCFS-0204	 Premier Freestanding Under Counter Lab Refrigerator, Solid Door, 2.5 cu. ft.	Call for Pricing
ABT-HC-UCFS-0204G	 Premier Freestanding Under Counter Lab Refrigerator, Glass Door, 2.5 cu. ft.	Call for Pricing

*Under 6 cu. ft. do not qualify for Instant Rebates even if Energy Star rated.

Heathrow True North® Cool Containers

Cat. No.	Description	List Price
HS28714K	Cool Container, Ice Bucket 4L, Black	\$125.89
HS28721G	Cool Container 1L Ice Pan, Green	\$ 83.06
HS28724B	Cool Container 4L Ice Pan, Blue	\$128.75
HS28729R	Cool Container 9L Ice Pan, Red	\$170.71



Freestanding Under Counter Lab Refrigerators

ABS Premier Freestanding Under Counter 5.2 cu. ft. Refrigerator

- Adjustable operating temperature range: 1°C to 10°C
- One swing door, right hinged, three adjustable shelves with guardrail on back
- Digital temperature display
- Microprocessor temperature controller, audible and visual high and low temperature alarms
- Two probes; one in air and one in glycol bottle, back wall evaporator cover
- Keyed door lock, LED interior light, magnetic door gasket for positive seal, cycle defrost, remote alarm contacts, 0.375" in probe access port, powder coat exterior, leveling legs, HFC-free refrigerant (R600a), foam insulation and packaging, 1/6 HP compressor, 115V, 60 Hz, 1.3 Amps
- Exterior dimensions (W x D x H): 23.75" x 24" x 32.125"
- Two year parts and labor warranty, plus an additional three year compressor parts only warranty,
- Note: This unit must have a 4" clearance on sides and back for adequate ventilation



ABS Premier Freestanding Under Counter 5.2 cu. ft. Refrigerator		
Cat. No.	Description	
ABT-HC-UCFS-0504	Premier Freestanding Under Counter Lab Refrigerator, Solid Door, 5.2 cu. ft.	Call for Pricing
ABT-HC-UCFS-0504G 	Premier Freestanding Under Counter Lab Refrigerator, Glass Door, 5.2 cu. ft.	Call for Pricing



*Under 6 cu. ft. do not qualify for Instant Rebates even if Energy Star rated.

Built-in Under Counter Lab Refrigerators

ABS Premier Built-in Under Counter Hydrocarbon 4.6 cu. ft. Refrigerator

- Digital temperature display
- Microprocessor temperature controller, audible and visual high and low temperature alarms
- Two adjustable shelves, one fixed shelf
- Keyed door lock, leveling legs, 1/8 HP
- Exterior dimensions (W x D x H): 23.75" x 25.50" x 33.375"
- Energy Star certified
- Two year parts and labor warranty, plus an additional three year compressor parts only warranty



ABS Premier Built-in Under Counter Hydrocarbon 4.6 cu. ft. Refrigerator		
Cat. No.	Description	
ABT-HC-UCBI-0404 	Premier Under Counter Built-in Lab Refrigerator, Solid Door, 4.6 cu. ft.	Call for Pricing
ABT-HC-UCBI-0404G 	Premier Under Counter Built-in Lab Refrigerator, Glass Door, 4.6 cu. ft.	Call for Pricing

ABT-HC-UCBI-0404G

Built-in Under Counter Lab Refrigerators

ABS Premier Under Counter Built-in ADA Compliant 4.6 cu. ft. Refrigerator



- Digital temperature display
- Microprocessor temperature controller, audible and visual high and low temperature alarms, remote alarm contacts
- Adjustable operating temperature range 1°C to 10°C
- One door, right hinged, two adjustable shelves, one fixed shelf
- Two probes; one in air and one in glycol bottle
- Keyed door lock, LED interior light, magnetic door gasket for positive seal, cycle defrost, remote alarm contacts, 0.375" in probe access port, powder coat exterior, leveling legs, HFC-free refrigerant (R600a), foam insulation and packaging, 1/8 HP compressor, 115V, 60 Hz, 1.74 Amps
- Two year parts and labor warranty, plus an additional three year parts warranty on compressor
- ADA compliant and Energy Star certified



ABT-HC-UCBI-0404-ADA



ABT-HC-UCBI-0404G-ADA

ABS Premier Under Counter Built-in ADA Compliant 4.6 cu. ft. Refrigerator		
Cat. No.	Description	
ABT-HC-UCBI-0404-ADA 	Premier Under Counter Built-in Lab Refrigerator, Solid Door, Exterior Dimensions (WxDxH): 23.75" x 24.5" x 31.9375", 4.6 cu. ft.	Call for Pricing
ABT-HC-UCBI-0404G-ADA 	Premier Under Counter Built-in Lab Refrigerator, Glass Door, Exterior Dimensions (WxDxH): 23.75" x 25.5" x 31.9375", 4.6 cu. ft.	Call for Pricing

*Under 6 cu. ft. do not qualify for Instant Rebates even if Energy Star rated.

ABS Standard Under Counter Flammable Storage Freestanding 5 cu. ft. Refrigerator

- Adjustable operating temperature range 1°C to 10°C
- Digital temperature display
- Microprocessor temperature controller, audible and visual high and low temperature alarms
- One solid door, right hinged (not reversible), three adjustable shelves
- Keyed door lock, integrated door handle, magnetic door gasket for positive seal, probe access port, high-density urethane foam cabinet and door insulation, HFC-free refrigerant (R600a), foam insulation and packaging, cycle defrost, 115V, 60 Hz, 1.2 Amps
- Exterior dimensions (W x D x H): 23.63" x 24.25" x 32.19"
- Two year parts and labor warranty



ABS Standard Under Counter Flammable Storage Freestanding 5 cu. ft. Refrigerator		
Cat. No.	Description	
ABT-FRP-04	Premier Under Counter Flammable Storage Freestanding Lab Refrigerator, 5 cu. ft.	Call for Pricing

Heathrow Tube Racks

Cat. No.	Description	List Price
HS120356	TracRack® Segmented Tube Rack, Purple	\$ 25.69
HS23229B	Cryogenic Vial Rack, 50-Place, 4 pack, Blue	\$101.30

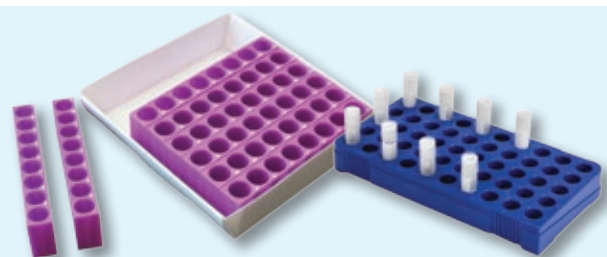

Upright Compact Lab Refrigerators

ABS Premier Compact 10.5 Cu. Ft. Laboratory Refrigerator

- Adjustable operating temperature range 1°C to 10°C
- One swing door, right hinged (not reversible), six adjustable shelves
- Microprocessor temperature controller, audible and visual high and low temperature alarms
- Digital temperature display
- Keyed door lock, magnetic door gasket for positive seal, two probes; one in air and one in sample bottle, probe access port 0.375", remote alarm contacts, forced draft circulation, back wall evaporator cover, leveling legs, LED interior light, HFC-free refrigerant (R600a), foam insulation and packaging, cycle defrost, 115V, 60 Hz, 2.3 Amps, Energy Star certified
- Exterior dimensions (W x D x H): 23.75" x 26.50" x 59"
- Two year parts and labor warranty, plus an additional three year compressor parts only warranty
- Note: This unit must have a 4" clearance on sides and back for adequate ventilation





ABT-HC-10PG



ABT-HC-10PS

ABS Premier Compact 10.5 Cu. Ft. Laboratory Refrigerator



Cat. No.	Description	
ABT-HC-10PG 	Premier Upright Compact Lab Refrigerator, Glass Door, 10.5 cu. ft.	Call for Pricing
ABT-HC-10PS 	Premier Upright Compact Lab Refrigerator, Solid Door, 10.5 cu. ft.	Call for Pricing

Upright Glass Door Lab Refrigerators

ABS Glass Door Laboratory Refrigerators

- Temperature range 1°C to 10°C
- Microprocessor temperature controller, audible and visual high and low temperature alarms
- Keyed door lock, magnetic door gasket for positive seal, two probes; one in air and one in sample bottle, probe access port, LED interior light, 3.5" swivel casters, cycle defrost, hydrocarbon, natural refrigerant R290, 115V, 60 Hz, Energy Star certified
- One year warranty parts and labor, additional four years on compressor parts

ABS Glass Door Laboratory Refrigerators

Cat. No.	Description	
ABT-HC-LS-16 	Upright Lab Refrigerator, Standard, Single Swing Self Closing Right Hinged Glass Door, 3 Adjustable Shelves, Exterior Dimensions (WxDxH): 25" x 29.75" x 79" with casters, 3 Amps, 16 cu. ft.	Call for Pricing
ABT-HC-LS-26 	Upright Lab Refrigerator, Standard, Glass Door, 4 Adjustable Shelves, Exterior Dimensions (WxDxH): 28.38" x 36.5" x 81.75" with casters, 3 Amps, 26 cu. ft.	Call for Pricing
ABT-HC-LS-49 	Upright Lab Refrigerator, Standard, Glass Door, Two Swinging Glass Doors, 8 Adjustable Shelves, Exterior Dimensions (WxDxH): 54" x 34.75" x 81.75" with casters, 4.5 Amps, 49 cu. ft.	Call for Pricing



ABT-HC-LS-16



ABT-HC-LS-26



ABT-HC-LS-49



Upright Glass Door Lab Refrigerators

K2 Scientific Life Science Performance Upright Refrigerators

- Intelligent microprocessor controller with digital display and adjustable temperature control, audible and visual high or low temperature alarms, magnetically sealed door with rapid cool-down mode, efficient, exterior, switch-activated interior LED lighting, 0.5" temperature probe and data logger access port, remote alarm contacts, six epoxy-coated wire shelves adjustable by 1-inch increments, keyed door lock, swivel casters, static (cycle) defrost, cabinet constructed of white powder-coated steel with CFC free, high density insulation
- Energy Star Rated, built and shipped from ISO 9001:2015
- CDC and VFC Compliant, EPA and SNAP Compliant
- Two-year parts, labor, or full replacement warranty



K2 Scientific Life Science Performance Upright Refrigerators		
Cat. No.	Description	List Price
K214GDR	Life Science Performance Upright Refrigerator, Exterior Dimensions (WxDxH): 23.62" x 26" x 72.13", Temperature Range 2°C to 8°C, Glass Door, 7 Shelves, 14 cu. ft.	\$2,522.47
K220GDR	Life Science Performance Upright Refrigerator, Exterior Dimensions (WxDxH): 30.38" x 27.75" x 76.6", Temperature Range 2°C to 8°C, Glass Door, 6 Shelves, 20 cu. ft.	\$3,084.85
K224GDR	Life Science Performance Upright Refrigerator, Exterior Dimensions (WxDxH): 29.13" x 35.50" x 77.56", Temperature Range 2°C to 8°C, Glass Door, 6 Shelves, 24 cu. ft.	\$3,702.85

Upright Solid Door Lab Refrigerators

ABS Standard Solid Door 26 cu. ft. Laboratory Refrigerator

- Adjustable operating temperature range 1°C to 10°C
- Microprocessor temperature controller, audible and visual high and low temperature alarms
- Digital temperature display
- Single swing solid door, right hinged (not reversible)
- Keyed door lock, magnetic door gasket for positive seal, probe access port, LED interior light, 3.5" swivel casters, four adjustable shelves, cycle defrost, hydrocarbon, natural refrigerant R290, 115V, 60 Hz, 3 Amps, Energy Star certified
- Exterior dimensions (W x D x H): 28.38" x 36.5" x 81.75" with casters
- One year parts and labor warranty, plus an additional four year compressor parts only warranty

ABS Standard Solid Door 26 cu. ft. Laboratory Refrigerator		
Cat. No.	Description	
ABT-HC-SLS-26 	Standard Upright Lab Refrigerator, Solid Door, 4 Adjustable Shelves, 26 cu. ft.	Call for Pricing



Upright Solid Door Lab Refrigerators

ABS Standard Double Solid Door 49 cu. ft. Laboratory Refrigerator

- Adjustable operating temperature range 1°C to 10°C
- Microprocessor temperature controller, audible and visual high and low temperature alarms
- Digital temperature display, remote alarm contacts
- Double swing solid doors, keyed door locks, magnetic door gasket for positive seal, two probes and access port, safety shielded LED interior lights, 3.5" swivel casters, eight adjustable shelves, forced draft air circulation, heavy-duty door handles, white powder coated steel interior and exterior, cycle defrost, hydrocarbon, natural refrigerant R290, 115V, 60 Hz, 4.5 Amps, 1/4 HP, ETL listed
- Exterior dimensions (W x D x H): 54" x 34.75" x 81.75"
- One year parts and labor warranty, plus an additional four year compressor parts only warranty



ABT-HC-SLS-49

ABS Standard Double Solid Door Laboratory Refrigerator

Cat. No.	Description	
ABT-HC-SLS-49	Standard Upright Lab Refrigerator, Double Solid Doors, 8 Adjustable Shelves, 49 cu. ft.	Call for Pricing

ABS Standard Upright Laboratory Refrigerators

- Digital microprocessor temperature controller
- Solid door right hinged (non-reversible), magnetic door gasket for positive seal, keyed door locks, heavy-duty door handle, leveling legs,
- One probe 0.75" access port, cycle defrost, white textured cabinet and door, high density urethane foam cabinet and door insulation, natural, hydrocarbon refrigerant (R600A), 115V, 60Hz, 2.5 Amps
- One year parts and labor warranty, plus an additional four year compressor parts only warranty



ABT-HC-RFP-14





ABT-HC-RFP-17



ABT-HC-RFP-20

ABS Standard Upright Laboratory Refrigerators

Cat. No.	Description	
ABT-HC-RFP-14 	Standard Upright Lab Refrigerator, 4 Adjustable Shelves and One Half Adjustable Shelf, Exterior Dimensions (WxDxH): 23.625" x 24.375" x 73", 1/5 HP, 14 cu. ft.	Call for Pricing
ABT-HC-RFP-17 	Standard Upright Lab Refrigerator, 5 Adjustable Shelves, Exterior Dimensions (WxDxH): 30.75" x 28.652" x 67.75", 115V, 60Hz, 2.5 Amps, 1/4 HP, 17 cu. ft.	Call for Pricing
ABT-HC-RFP-20 	Standard Upright Lab Refrigerator, 4 Adjustable Shelves and One Half Adjustable Shelf, Exterior Dimensions (WxDxH): 30.75" x 29" x 74.652", 115V, 60Hz, 2.5 Amps, 1/4 HP, 20 cu. ft.	Call for Pricing

Upright Solid Door Lab Refrigerators

K2 Scientific Life Science Performance Upright Refrigerators

- Audible/visual high or low temperature alarms, magnetically sealed door with rapid cool-down mode, efficient, exterior, switch activate interior LED lighting, 0.5" temperature probe and data logger access port, remote alarm controls, six epoxy-coated wire shelves adjustable in 1" increments, keyed door lock, swivel casters, static cycle defrost, cabinet constructed of white powder-coated steel with CFC free, high density insulation
- Built and shipped from ISO 9001:2015 facilities, CDC and VFC Compliant, EPA and SNAP compliant
- Two-year parts, labor, or full replacement warranty



K2 Scientific Life Science Performance Upright Refrigerators

Cat. No.	Description	List Price
K214SDR	Life Science Performance Upright Refrigerator, Exterior Dimensions (WxDxH): 23.62" x 26" x 72.13", Temperature Range 2°C to 8°C, Solid Door, 7 Shelves, 14 cu. ft.	\$2,522.47
K220SDR	Life Science Performance Upright Refrigerator, Exterior Dimensions (WxDxH): 30.38" x 27.75" x 76.6", Temperature Range 2°C to 8°C, Solid Door, 6 Shelves, 20 cu. ft.	\$3,084.85
K224SDR	Life Science Performance Upright Refrigerator, Exterior Dimensions (WxDxH): 29.13" x 33.94" x 77.56", Temperature Range 2°C to 8°C, Solid Door, 6 Shelves, 24 cu. ft.	\$3,702.85



Upright Flammable Storage Lab Refrigerators

ABS Flammable Storage Refrigerators

- Adjustable operating temperature range 1°C to 10°C
- Microprocessor temperature controller, audible and visual high and low temperature alarms
- Digital temperature display, remote alarm contacts
- One solid right hinged swing door, keyed door lock, magnetic door gasket for positive seal, two probes: one in air and one in sample bottle, 0.75 rear external probe access, heavy-duty door handles, white textured cabinet and door, cycle defrost, leveling legs, high density urethane foam cabinet and door insulation, natural, hydrocarbon R600A refrigerant, 115V, 60 Hz, 2.5 Amps
- Two year parts and labor warranty



ABS Flammable Storage Refrigerator



Cat. No.	Description	
ABT-HC-FRP-14 	Standard Upright Flammable Storage Lab Refrigerator, 4 Adjustable Shelves and One Half Adjustable Shelf, Exterior Dimensions (WxDxH): 23.625" x 24.375" x 73", 1/5 HP, ETL Listed, 14 cu. ft.	Call for Pricing
ABT-HC-FRP-17 	Standard Upright Flammable Storage Lab Refrigerator, 5 Adjustable Shelves, Exterior Dimensions (WxDxH): 30.75" x 28.625" x 67.75", 1/4 HP, 17 cu. ft.	Call for Pricing
ABT-HC-FRP-20 	Standard Upright Flammable Storage Lab Refrigerator, 4 Adjustable Shelves and One Half Adjustable Shelf, Exterior Dimensions (WxDxH): 30.75" x 29" x 74.625", 1/4 HP, 20 cu. ft.	Call for Pricing

Upright Hazardous Location Lab Refrigerators

ABS Hazardous Location Refrigerators

- Adjustable operating temperature range 1°C to 10°C
- Microprocessor temperature controller, audible and visual high and low temperature alarms
- Solid door right hinged (non-reversible), magnetic door gasket for positive seal, keyed door lock, heavy-duty door handle, leveling legs
- Cycle defrost, white textured cabinet and door, high density urethane foam cabinet and door insulation, natural, hydrocarbon refrigerant (R600A), 115V, 60Hz, 2.5 Amps
- Two year parts and labor warranty
- Not equipped with plug; must be hardwired in conduit, ETL Listed, meets NFPA and OSHA guidelines for hazardous locations, Class 1 Division II, Group C and D



ABS Hazardous Location Refrigerator		
Cat. No.	Description	
ABT-HC-ERP-14 	Standard Upright Hazardous Location Lab Refrigerator, 4 Adjustable Shelves and One Half Adjustable Shelf, Exterior Dimensions (WxDxH): 23.625" x 24.375" x 73", 1/5 HP, 14 cu. ft.	Call for Pricing
ABT-HC-ERP-17 	Standard Upright Hazardous Location Lab Refrigerator, 5 Adjustable Shelves, Exterior Dimensions (WxDxH): 30.75" x 28.625" x 67.75", 1/4 HP, 17 cu. ft.	Call for Pricing
ABT-HC-ERP-20 	Standard Upright Hazardous Location Lab Refrigerator, 4 Adjustable Shelves and One Half Adjustable Shelf, Exterior Dimensions (WxDxH): 30.75" x 29" x 74.625", 1/4 HP, 20 cu. ft.	Call for Pricing

Pharmacy/ Lab Refrigerators

Haier Benchtop Pharmacy Lab Refrigerator

- Adjustable operating temperature range 2°C to 8°C
- Microprocessor control, multiple alarm system
- Wire basket, auto defrost, LED display and interior light, CFC-free refrigerant, forced air cooling, 115V, 60Hz
- Interior dimensions (WxDxH): 16.3" x 15.2" x 19.9"; Exterior dimensions (WxDxH): 21.3" x 25.2" x 28"
- Three year parts and labor warranty, plus an additional five year compressor warranty

Haier Benchtop Pharmacy Lab Refrigerator		
Cat. No.	Description	List Price
HYC-68	Benchtop Pharmacy Lab Refrigerator, Solid Door, 2 Adjustable Shelves, 1 Drawer, 2.4 cu. ft.	\$1,495.00
HYC-68A	Benchtop Pharmacy Lab Refrigerator, Glass Door, 2 Adjustable Shelves, 1 Drawer, 2.4 cu. ft.	\$1,495.00



Haier Under Counter Pharmacy Lab Refrigerator

- Adjustable operating temperature range 2°C to 8°C
- Microprocessor control, multiple alarm system
- Wire basket, auto defrost, LED display and interior light, CFC-free refrigerant, forced air cooling, access port, lock and key, 115V, 60Hz
- Interior dimensions (WxDxH): 20.3" x 16.3" x 24.8";
Exterior dimensions (WxDxH): 23.5" x 25" x 32.9"
- Three year parts and labor warranty, plus an additional five year compressor warranty



Haier Under Counter Pharmacy Lab Refrigerator		
Cat. No.	Description	List Price
HYC-118	Under Counter Pharmacy Lab Refrigerator, Solid Door, 3 Adjustable Shelves, One Drawer, 4.2 cu. ft.	\$1,695.00
HYC-118A	Under Counter Pharmacy Lab Refrigerator, Glass Door, 3 Adjustable Shelves, One Drawer, 4.2 cu. ft.	\$1,695.00

Haier Upright 10 cu. ft. Pharmacy Lab Refrigerator

- Adjustable operating temperature range 2°C to 8°C
- Single heated double pane self-closing glass door with 90° stay-open feature
- Microprocessor control with USB data port, multiple alarm system
- Auto defrost, LED display and interior light, CFC-free refrigerant, forced air cooling, access port, lock and key, 115V, 60Hz
- Interior dimensions (WxDxH): 20.9" x 21.9" x 42.5";
Exterior dimensions (WxDxH): 26.2" x 28" x 65.6"
- Three year parts and labor warranty, plus an additional five year compressor warranty



Haier Upright 10 cu. ft. Pharmacy Lab Refrigerator		
Cat. No.	Description	List Price
HYC-290	Upright Pharmacy Lab Refrigerator, Glass Door, 4 Adjustable Shelves, 10 cu. ft.	\$2,295.00

Haier Double Glass Door Upright Pharmacy Lab Refrigerator

- Adjustable operating temperature range 2°C to 8°C
- Microprocessor control with USB data port, multiple alarm system
- 12 adjustable shelves with clear slots for storage label cards, self-closing doors
- Auto defrost, LED display and interior light, CFC-free refrigerant, forced air cooling, access port, lock and key, 115V, 60Hz
- Interior dimensions (WxDxH): 52.0" x 27.6" x 59.1";
Exterior dimensions (WxDxH): 56.7" x 36.4" x 78"
- Three year parts and labor warranty, plus an additional five year compressor warranty



Haier Double Glass Door Upright Pharmacy Lab Refrigerator		
Cat. No.	Description	List Price
HYC-1378	Upright Pharmacy Lab Refrigerator, Double Glass Door, 12 Adjustable Shelves, 48.7 cu. ft.	\$8,995.00

Pharmacy/ Lab Refrigerators

Haier Upright Pharmacy Lab Refrigerator

- Adjustable operating temperature range 2°C to 8°C
- Microprocessor control with USB data port, multiple alarm system
- Auto defrost, LED display and interior light, HC refrigerant, forced air cooling, access port, lock and key, 115V, 60Hz
- Interior dimensions (WxDxH): 24.4" x 27.8" x 59.8";
Exterior dimensions (WxDxH): 29.9" x 35.3" x 78.5"
- Three year parts and labor warranty, plus an additional five year compressor warranty
- UL and Energy Star certified



Haier Upright Pharmacy Lab Refrigerator

Cat. No.	Description	List Price
HYC-639	Upright Pharmacy Lab Refrigerator, Single Glass Door, 4 Adjustable Shelves, 22.5 cu. ft.	\$5,300.00

Accessories

K2 Scientific Vitallog Vital Power Supply (VPS) Battery Backup

- Safer, longer lasting LiFePO4 batteries, transfer time of 0 milliseconds, 6000 cycles before 80% capacity, 7kWh total energy storage, 1400W max continuous power
- Smart-Sync with VPL and other VL products (text message, email, Wi-Fi, run-time and power usage)
- VitalLog cloud storage, alerts and analytics



Technical Specifications

Performance Specifications		Compliance Information	
■ Model	VL-UPS-US-7KW	■ Plug Type	NEMA 5-15
■ Total Energy Storage	7.168kWh	■ Grid Connections	U.S. & Canada
■ Max. Continuous Power	2000W	Environmental Specifications	
■ Input Voltage Range	95-140 VAC	■ Communication Port	UART/BT/RS485/CAN, RS232, USB
■ Input/Output Frequency	50Hz/60Hz Auto Sensing	■ Operating/Storage Temp	0°C to 55°C / -15°C to 60°C
■ Output Voltage	120VAC ± 5%	■ Operating Humidity	5% to 95% Relative (Non-Condensing)
■ Output Waveform	Pure Sine Wave	■ Environment	Indoor
■ Peak Efficiency (ECO mode)	98%	Mechanical Specifications	
■ Peak Efficiency (Battery mode)	90%	■ Weight	173 lbs
■ Nominal Battery Voltage	24V	■ Dimensions (D x W x H)	22.56" x 15.44" x 20.44"
■ Maximum Battery Voltage	32V	K2 Vitallog Vital Power Supply (VPS) Battery Backup	
■ Transfer Time (AC Mode to Batt. Mode)	0ms	Cat. No.	Description
■ Charging Mode	3-stage	VL-UPS-US-7KW	K2 Scientific Vitallog VPS Battery Backups 7KwH
■ Max AC Charging Current	60A	List Price	\$6,995.00
■ Battery Type	Lithium Iron Phosphate (LiFePo4)		
■ Warranty	7 years		

ABS Refrigerator Baskets

- Designed to fit 10.5 cu. ft. compact refrigerators and 5.2 cu. ft. freestanding undercounter refrigerators.
- Sturdy construction allows you to stack and organize inventory for efficiency and easy accessibility.
- Designed to promote superior air circulation, preventing hot spots and maintaining consistent temperatures throughout the chamber.
- Improves the shelf life of your products and reduces the risk of spoilage.

ABS Refrigerator Baskets		
Cat. No.	Description	
ABT-SLD BSKT-FULL-10.5	Basket Slide Assembly for 10.5 cu. ft. Refrigerators	Call for Pricing
ABT-BSKT-BASE-FIXED-10.5	Half Basket Fixed on Bottom of Unit for 10.5 cu. ft. Refrigerators	Call for Pricing
ABT-SLD BSKT-FULL-0504	Basket Slide Assembly for 5.2 cu. ft. Refrigerators	Call for Pricing
ABT-BSKT-BASE-FIXED-0504	Half Basket Fixed on Bottom of Unit for 5.2 cu. ft. Refrigerators	Call for Pricing

Disclaimer: Basket Slide Assemblies are factory-installed accessories. The unit and the basket(s) must be ordered together. 10.5 cu. ft. units can replace up to 6 full sliding Baskets and 1 half-size, bottom-mounted fixed basket. Lesser basket quantities can be ordered for each refrigerator and will be installed from the bottom of the unit upwards and equally spaced.



MTC Bio Flip 'n Fold™ Sterile Sampling Bags

- Virgin polyethylene for excellent clarity and strength, gamma sterilized
- Meet USDA, EPA, and FDA standards, are RNase, DNase free, non-pyrogenic



Flip 'n Fold™ Sterile Sampling Bags		
Cat. No.	Description	List Price
B5750	Sterile Sampling Bag, 2 oz. (127 x 76mm), 500 per pack	\$ 80.40
B5760	Sterile Sampling Bag, 4 oz. (178 x 76mm), 500 per pack	\$ 83.40
B5761	Sterile Sampling Bag, 4 oz. (178 x 76mm), with marking area 60 x 65mm, 500 per pack	\$ 90.00
B5770	Sterile Sampling Bag, 18 oz. (229 x 114mm), 500 per pack	\$109.80
B5771	Sterile Sampling Bag, 18 oz. (229 x 114mm) with marking area 60 x 105mm, 500 per pack	\$138.00
B5780	Sterile Sampling Bag, 27 oz. (304 x 114mm), 500 per pack	\$166.80
B5790	Sterile Sampling Bag, 36 oz. (381 x 114mm), 500 per pack	\$186.00
B5910	Sterile Sampling Bag, 55 oz. (300 x 180mm), 250 per pack	\$178.80
B5911	Sterile Sampling Bag, 55 oz. (300 x 180mm) with marking area 80 x 160mm, 250 per pack	\$210.00

Countertop and Under Counter Freezers

ABS Premier Hydrocarbon Freestanding Countertop Laboratory Freezer

- Microprocessor temperature controller, digital temperature display
- Adjustable operating temperature range: -15 to -25°C
- Audible and visual high and low temperature alarms, remote alarm contacts
- One solid right hinged swing door, two adjustable shelves, keyed door lock, magnetic door gasket for positive seal, two probes: one in air and one in Glycol bottle, 0.375" probe access port, powder coat exterior, foam insulation and packaging, leveling legs, high density urethane foam cabinet and door insulation, HFC-free R600A refrigerant, 115V, 60 Hz, 1 Amp, 1/8 HP
- Exterior dimensions (W x D x H): 23.75" x 24"x 20.375"
- Unit must have 4" clearance on sides and back for adequate ventilation
- Two year parts and labor warranty, plus additional three year compressor parts only warranty
- UL/C-UL Listed, Energy Star Certified



ABT-HC-UCFS-0120



ABT-HC-UCFS-0120A

ABS Premier Hydrocarbon Freestanding Countertop Laboratory Freezers

Cat. No.	Description	
ABT-HC-UCFS-0120	Premier Hydrocarbon Freestanding Countertop Laboratory Freezer, Manual Defrost, 1.7 cu. ft.	Call for Pricing
ABT-HC-UCFS-0120A	Premier Hydrocarbon Freestanding Countertop Laboratory Freezer, Auto Defrost Cycle Every Six Hours, HFC-Free Refrigerant (R600A), 1.3 cu. ft.	Call for Pricing

ABS Standard Freestanding Under Counter Freezer

- Mechanical thermostat, average cycle temperature: -20°C
- One solid right hinged swing door, one fixed shelf, keyed door lock, magnetic door gasket for positive seal, probe access port, manual defrost, foam insulation and packaging, leveling legs, HFC-free R600A refrigerant, 115V, 60 Hz, 1.1 Amps
- Exterior dimensions (W x D x H): 18.5" x 19.5"x 19.5"
- Unit must have 4" clearance on sides and back for adequate ventilation
- One year parts and labor warranty



ABS Standard Freestanding Under Counter Freezer

Cat. No.	Description	
ABT-HC-UCFS-0220M	Standard Freestanding Under Counter Laboratory Freezer, 1.5 cu. ft.	Call for Pricing

ABS Built-in Under Counter Hydrocarbon Freezer

- Microprocessor temperature controller, average cycle temperature: -20°C, audible and visual temperature alarms
- Digital temperature display, keyed door lock, leveling legs, manual defrost, two fixed shelves, 115V, 60Hz, 1/8 HP
- Exterior dimensions (W x D x H): 23.75" x 24.50"x 33.375"
- Two year parts and labor warranty, plus additional three year compressor parts only
- Energy Star Certified



ABS Built-in Under Counter Hydrocarbon Freezer

Cat. No.	Description	
ABT-HC-UCBI-0420	Premier Built-in Under Counter Lab Freezer, Solid Door, 4.2 cu. ft.	Call for Pricing

*Under 6 cu. ft. do not qualify for Instant Rebates even if Energy Star rated.

Countertop and Under Counter Freezers

ABS Premier Built-in Under Counter Freezer

- Microprocessor temperature controller, digital temperature display
- Adjustable operating temperature range: -15 to -25°C
- Audible and visual high and low temperature alarms, remote alarm contacts
- One solid right hinged door, keyed door lock, magnetic door gasket for positive seal, two probes: one in air and one in sample bottle, 0.375" probe access port, powder coat exterior, foam insulation and packaging, leveling legs, 1/8 HP compressor, recessed door handle, front breathing ventilation system, HFC-free R600A refrigerant, 115V, 60 Hz, 1.5 Amp
- Unit must have 4" clearance on sides and back for adequate ventilation
- Two year parts and labor warranty, plus additional three year compressor parts only warranty
- Energy Star Certified, ADA compliant (ABT-HC-UCBI-0420-ADA model only)



ABT-HC-UCBI-0420-ADA



ABT-HC-UCBI-0420A

ABS Premier Built-In Under Counter Freezer

Cat. No.	Description	
ABT-HC-UCBI-0420-ADA	Premier Built-in Under Counter Laboratory Freezer, Two Fixed Shelves, Manual Defrost, Exterior Dimensions (WxDxH): 23.75" x 24.5" x 31.937", 4.2 cu. ft.	Call for Pricing
ABT-HC-UCBI-0420A	Premier Built-in Under Counter Laboratory Freezer, 3 Adjustable Shelves, Exterior Dimensions (WxDxH): 23.75" x 24.50" x 33.13", Auto Defrost, 4.2 cu. ft.	Call for Pricing

ABS Premier Under Counter Freestanding Laboratory Freezer

- Adjustable operating temperature range: -15 to -25°C
- Microprocessor temperature controller, average cycle temperature: -20°C, digital temperature display
- Audible and visual high and low temperature alarms, remote alarm contacts
- One solid right hinged swing door (not reversible), keyed door lock, recessed handle, two fixed shelves and bottom shelf, magnetic door gasket for positive seal, 0.375" probe access port, manual defrost, high density urethane foam insulation, leveling legs, back wall evaporator cover, LED interior light, white exterior, HFC-free R600A refrigerant, 115V, 60 Hz
- Exterior dimensions (W x D x H): 23.625" x 24.25" x 32.187"
- Unit must have 4" clearance on sides and back for adequate ventilation
- Two year parts and labor warranty, plus additional three year compressor parts only warranty



ABS Premier Under Counter Freestanding Laboratory Freezer

Cat. No.	Description	List Price
ABT-HC-UCFS-0520	Premier Under Counter Freestanding Laboratory Freezer, 4 cu. ft.	Call for Pricing

MTC Bio SureSeal™ Sterile Transport Tubes

- Sterile with leakproof caps attached
- Meet 95kPa transport guidelines
- Graduations and marking spots

SureSeal™ Sterile Transport Tubes

Cat. No.	Description	List Price
C1813	Sterile Transport Tubes, 5mL, 16x56mm, with O-ring Sealing Cap	\$199.00
C1814	Sterile Transport Tubes, 19mL, 16x92mm, with O-ring Sealing Cap	\$239.00



Countertop and Under Counter Freezers

ABS Standard Under Counter Freestanding Laboratory Freezer

- Mechanical thermostat, adjustable operating temperature range: -15 to -25°C
- One solid door, keyed door lock, recessed handle, four drawers, magnetic door gasket for positive seal, 0.375" probe access port, manual defrost, high density urethane foam cabinet and door insulation, leveling legs, white cabinet and door, HFC-free R600A refrigerant, 1/7 HP compressor, 115V, 60 Hz, 0.9 Amps, UL/C-UL listed
- Exterior dimensions (W x D x H): 20.25" x 21.625" x 31.5"
- Unit must have 4" clearance on sides and back for adequate ventilation
- One year parts and labor warranty,



ABS Standard Under Counter Freestanding Laboratory Freezer

Cat. No.	Description	
ABT-HC-UCFS-0420W	Standard Under Counter Freestanding Laboratory Freezer, 4 cu. ft.	Call for Pricing

ABS Premiere Under Counter Flammable Freezer

- Adjustable operating temperature range: -15 to -25°C
- Microprocessor temperature controller, audible and visual temperature alarms
- One solid right hinged swinging door (not reversible), keyed door lock, integrated door handle, two fixed shelves with three removable baskets, magnetic door gasket for positive seal, probe access, manual defrost, high density urethane foam cabinet and door insulation and packaging, HFC-free R600A refrigerant, 115V, 60 Hz
- Exterior dimensions (W x D x H): 23.63" x 24.25" x 32.188"
- Unit must have 4" clearance on sides and back for adequate ventilation
- Two year parts and labor warranty



ABS Standard Under Counter Freestanding Laboratory Freezer

Cat. No.	Description	
ABT-FFP-04	Premier Under Counter Flammable Laboratory Freezer, 4 cu. ft.	Call for Pricing

MTC Bio ProSeries Performance Centrifuge Tubes

- 20,000xg maximum centrifugation rate
- Hi-Viz™ graduations including maximum freeze capacity line
- FreezeTech™ temperature indicator changes color at 0°C
- Available in resealable zip bags Eco-Plastic racks
- E-Beam sterilized SAL 10⁻⁶

IceRack™ Crushed Ice Tube Racks

Cat. No.	Description	List Price
C2800	ProSeries Tubes Centrifuge Tube, 15mL, Sterile, w/Temp Indicator, 20 racks of 25 tubes, 500/CS	\$189.00
C2801	ProSeries Tubes Centrifuge Tube, 15mL, Sterile, w/Temp Indicator, 20 bags of 25 tubes, 500/CS	\$178.00
C2802	ProSeries Tubes Centrifuge Tube, 50mL, Sterile, w/Temp Indicator, 20 racks of 25 tubes, 500/CS	\$219.00
C2803	ProSeries Tubes Centrifuge Tube, 50mL, Sterile, w/Temp Indicator, 20 bags of 25 tubes, 500/CS	\$199.00



Haier Upright Biomedical Laboratory Freezer

- Mechanical thermostat, average cycle temperature: -25°C
- Adjustable operating temperature range: -10 to -25°C
- Microprocessor temperature controller, multiple malfunction alarms including high or low temperature and sensor error
- Direct cooling, manual defrost, LCD display, three drawers, USB interface, HFC-free R600A refrigerant, 115V, 60 Hz
- Three year parts and labor warranty, plus additional five year compressor parts only warranty



Haier Upright Biomedical Laboratory Freezer		
Cat. No.	Description	List Price
DW-25L92	Haier Upright Biomedical Freezer, 3.2 cu. ft. (92L), Interior Dimensions (WxDxH): 17.1" x 16.1" x 25", Exterior Dimensions (WxDxH): 25.2" x 24" x 31.9", Solid Door, 2 Fixed Shelves	\$1,895.00
DW-25L262	Haier Upright Biomedical Freezer, 9.3 cu. ft. (262L), Interior Dimensions (WxDxH): 18.9" x 18.3" x 56.3", Exterior Dimensions (WxDxH): 27.6" x 27.8" x 68.1", Solid Door, 6 Fixed Shelves	\$2,195.00



Haier Upright Double Door Biomedical Laboratory Freezer

- Mechanical thermostat, average cycle temperature: -30°C
- Adjustable operating temperature range: -10 to -30°C
- Microprocessor temperature controller, multiple malfunction alarms including high or low temperature and sensor error
- Direct cooling, manual defrost, LCD display, two drawers, porthole, casters, HFC-free R600A refrigerant, 115V, 60 Hz
- Interior dimensions (WxDxH): 27.7" x 24.4" x 48.4"; Exterior (WxDxH): 37" x 33.3" x 73.9"
- Three year parts and labor warranty, plus additional 5 year compressor parts only warranty



Haier Upright Double Door Biomedical Freezer		
Cat. No.	Description	List Price
DW-30L528D	Haier Upright Double Door Biomedical Freezer, 18.8 cu. ft. (531L)	\$4,500.00

*General Purpose units do not qualify for Instant Rebates even when they are Energy Star rated. Only High Efficiency units are part of the program.

MTC Bio IceRack™ Crushed Ice Tube Racks

- For use with crushed ice
- Polypropylene -86° to 135°C
- Detachable lift-off lids
- For screw cap and snap cap tubes



IceRack™ Crushed Ice Tube Racks		
Cat. No.	Description	List Price
R8012	Ice Rack for 72 x 0.5mL tubes, 6/case	\$29.50
R8013	Ice Rack for 72 x 1.5mL tubes, 6/case	\$29.50
R8014	Ice Rack for 100 x 1.5mL tubes, 6/case	\$34.50



Haier Upright Biomedical Laboratory Freezer

- Mechanical thermostat, average cycle temperature: -30°C
- Adjustable operating temperature range: -10 to -30°C, microprocessor temperature controller
- Direct cooling, manual defrost, LED display, five adjustable drawers, HC refrigerant, 115V, 60 Hz
- Three year parts and labor warranty, plus additional five year compressor parts only warranty





Haier Upright Biomedical Laboratory Freezer		
Cat. No.	Description	List Price
DW-30L698 	Haier Upright Biomedical Freezer, 24.7 cu. ft. (698L), Multiple Alarms, Two Access Ports, 3 Inner Doors, Interior Dimensions (WxDxH): 25.2" x 29.7" x 57.4"; Exterior Dimensions (WxDxH): 34.4" x 36.6" x 78.1"	\$6,600.00
DW-30L818BP 	Haier Upright Biomedical Freezer, 28.8 cu. ft. (818L), Interior Dimensions (WxDxH): 29.5" x 29.7" x 57.5"; Exterior Dimensions (WxDxH): 38.9" x 37.4" x 78"	\$8,995.00

Manual Defrost Upright Freezers

ABS Premier Hydrocarbon Manual Defrost Laboratory Freezer

- Adjustable operating temperature range -15°C to 25°C
- Microprocessor temperature controller, audible and visual high and low temperature alarms, remote alarm contacts
- Digital temperature display, solid door right hinged, two probes: one in air and one in Glycol bottle, six fixed shelves, magnetic door gasket for positive seal, keyed door lock, leveling legs, 3/4" probe access port
- Powder coat exterior, high density urethane foam cabinet and door insulation, foam insulation and packaging, HFC-free refrigerant (R290), 115V, 60Hz, UL/C-UL or ETL listed, Energy Star certified
- Unit must have 4" clearance on sides and back for adequate ventilation
- Two year parts and labor warranty, plus additional three year compressor parts only warranty





ABS Premier Hydrocarbon Manual Defrost Laboratory Freezer		
Cat. No.	Description	
ABT-HC-MFP-14 	Premier Hydrocarbon Manual Defrost Laboratory Freezer, Exterior Dimensions (WxDxH): 23.625" x 24.375" x 73", 14 cu ft., 3 Amps, 1/3 HP	Call for Pricing
ABT-HC-MFP-17 	Premier Hydrocarbon Manual Defrost Laboratory Freezer, Exterior Dimensions (WxDxH): 30.75" x 28.625" x 67.75", 17 cu ft., 5.5 Amps, 1/2 HP	Call for Pricing
ABT-HC-MFP-20 	Premier Hydrocarbon Manual Defrost Laboratory Freezer, Exterior Dimensions (WxDxH): 30.75" x 29" x 74.625", 20 cu. ft., 5.5 Amps, 1/2 H	Call for Pricing

Manual Defrost Upright Freezers

K2 Scientific Upright Laboratory Freezers

- Temperature range -10°C to -25°C, intelligent microprocessor controller with digital display and adjustable temperature control, manual defrost, audible and visual high or low temperature alarms, magnetically sealed door with rapid cool-down mode after door opening, efficient, exterior switch-activated interior LED lighting
- White epoxy-coated wire shelves, adjustable by 1" increments, cabinet constructed of white powder-coated steel with CFC-free, high density insulation, R600a refrigerant, forced air circulation aids temperature stability and uniformity, easy swivel casters, keyed door lock, remote alarm contacts
- 0.50" temperature probe and data logger access port, each cabinet undergoes three quality control checks prior to shipping
- cULus, ISO 9001:2015, Energy Star, CDC and VFC Compliant, EPA and SNAP compliant
- Two-year parts, labor or full replacement warranty



K2 Upright Laboratory Freezers		
Cat. No.	Description	List Price
K210SDF 	Upright Laboratory Freezer, 10 cu. ft., Exterior Dimensions (WxDxH): 23.6" x 22.5" x 60.2", 6 Shelves	\$2,222.59
K214SDF	Upright Laboratory Freezer, 14 cu. ft., Exterior Dimensions (WxDxH): 23.62" x 26" x 72.13", 7 Shelves	\$2,522.47
K220SDF 	Upright Laboratory Freezer, 20 cu. ft., Exterior Dimensions (WxDxH): 30.38" x 27.75" x 76.6", 6 Shelves	\$3,084.85
K224SDF	Upright Laboratory Freezer, 24 cu. ft., Exterior Dimensions (WxDxH): 29.13" x 33.94" x 77.56", 6 Shelves	\$4,114.85

*General Purpose units do not qualify for Instant Rebates even when they are Energy Star rated. Only High Efficiency units are part of the program.



Heathrow Upright Freezer Racks

Cat. No.	Description	List Price
HS28622	2x3 Upright Freezer Rack 5" (130mm), Steel	\$191.19
HS2862H	4x4 Upright Freezer Rack, Stainless Steel, 2", Steel	\$195.08
HS2862HA	4x3 Upright Freezer Rack, Stainless Steel, 2", Steel	\$183.26
HS2862HB	5x4 Upright Freezer Rack, Stainless Steel, 2", Steel	\$266.90
HS2862KB	4x4 Upright Freezer Rack, Stainless Steel, 3", Steel	\$257.70
HS2862KC	5x4 Upright Freezer Rack, Stainless Steel, 3", Steel	\$294.52

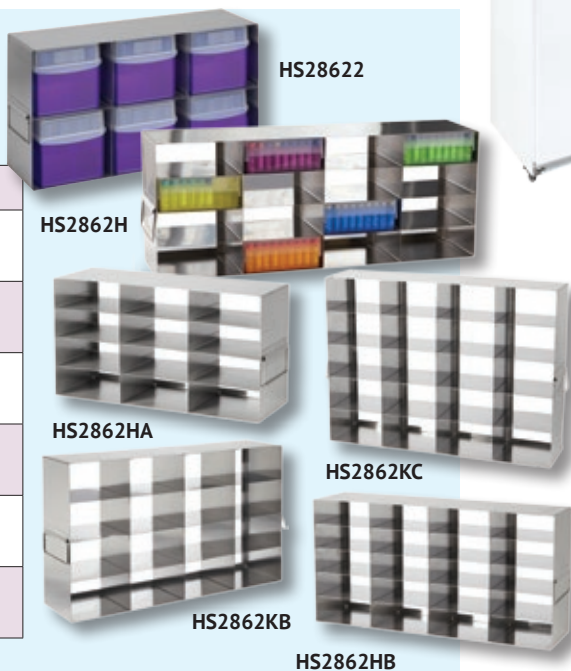

Manual Defrost Freezer Chests

K2 Scientific Manual Defrost Chest Freezers

- Temperature range -10°C to -45°C
- Intelligent microprocessor controller with digital display and adjustable temperature control, visual and audible high or low temperature, sensor failure, door open alarms, keyed door locks, easy swivel casters
- Cabinet constructed of white powder-coated 304 steel with CFCfree, high density insulation, each cabinet undergoes three quality control checks prior to shipping
- ISO: 9001:2015, CDC and VFC Compliant, EPA and SNAP Compliant
- UL listed (K20745-C only)
- Two-year parts, labor or full replacement warranty



K2 Scientific Manual Defrost Chest Freezers		
Cat. No.	Description	List Price
K20345-C	Chest Freezer, 3.5 cu. ft., Exterior Dimensions (WxDxH): 27.25" x 22" x 33.5", 1 Basket	\$1,586.05
K20745-C	Chest Freezer, 7 cu. ft., Exterior Dimensions (WxDxH): 37.13" x 30.5" x 35", 2 Baskets	\$2,275.63
K21145-C	 Chest Freezer, 11 cu. ft., Exterior Dimensions (WxDxH): 50.25" x 27.75" x 33.5", 2 Baskets	\$2,912.17
K22145-C	Chest Freezer, 21 cu. ft., Exterior Dimensions (WxDxH): 71.00" x 29.75" x 34.69", 2 Baskets	\$3,849.00

*General Purpose units do not qualify for Instant Rebates even when they are Energy Star rated. Only High Efficiency units are part of the program.

Auto Defrost Upright Freezers

ABS Premier Hydrocarbon Auto Defrost Laboratory Freezer

- Adjustable operating temperature range -15°C to -25°C
- Microprocessor temperature controller, audible and visual high and low temperature alarms, remote alarm contacts
- Digital temperature display, solid door, two probes, three adjustable shelves, magnetic door gasket for positive seal, keyed door lock, auto defrost, LED interior lights, switch controlled, probe access port, four casters
- Stainless steel exterior, high density urethane foam cabinet and door insulation, foam insulation and packaging, HFC-free refrigerant (R290), 115V, 60Hz, 8 Amps, 3/4 HP, UL/C-UL listed, Energy Star certified
- Exterior dimensions (WxDxH): 26.875" x 35.75" x 83.25"
- Unit must have 4" clearance on sides and back for adequate ventilation
- Two year parts and labor warranty, plus additional three year compressor parts only warranty



ABS Premier Hydrocarbon Auto Defrost Laboratory Freezer		
Cat. No.	Description	
ABT-HC-SSP-23FA	Premier Hydrocarbon Auto Defrost Laboratory Freezer, 23 cu. ft.	Call for Pricing

Auto Defrost Upright Freezers

ABS Standard Auto Defrost Hydrocarbon Laboratory Freezer

- Adjustable operating temperature range -15°C to -20°C
- Mechanical Thermostat, single solid swing door right hinged (not reversible), heavy duty door handle, magnetic door gasket for positive seal, keyed door lock, four adjustable shelves with one wire basket, auto defrost, leveling legs, probe access port
- White textured cabinet and door, HFC-free refrigerant (R600a), 115V, 60Hz, 5 Amps, CSA listed
- One year parts and labor warranty, plus an additional four year compressor parts only warranty



ABS Standard Auto Defrost Hydrocarbon Laboratory Freezer

Cat. No.	Description	
ABT-HC-AFS-1420	Auto Defrost Hydrocarbon Laboratory Freezer, 14 cu. ft., Interior Dimensions (WxDxH): 21.375" x 14.25" x 59.75", Exterior Dimensions (WxDxH): 28" x 26.25" x 67.75"	Call for Pricing
ABT-HC-AFS-1720	Auto Defrost Hydrocarbon Laboratory Freezer, 17 cu. ft., Interior Dimensions (WxDxH): 21.375" x 17.5" x 59.75", Exterior Dimensions (WxDxH): 28" x 29.75" x 68"	Call for Pricing



Flammable Storage Upright Freezers

ABS Premier Hydrocarbon Flammable Storage Freezer

- Adjustable operating temperature range -15°C to -25°C
- Microprocessor temperature controller, audible and visual high and low temperature alarms, remote alarm contacts
- Digital temperature display, solid swing door right hinged, two probes 1 in air 1 in sample bottle, 3/4" probe access port (0.75"), six fixed shelves, magnetic door gasket for positive seal, keyed door lock, manual defrost, leveling leg
- Powder coat exterior, foam insulation and packaging, natural hydrocarbon refrigerant (R290), 115V, 60Hz, ETL Listed, unit meets NFPA Guidelines 45 and 30
- Unit must have 4" clearance on sides and back for adequate ventilation
- Two year parts and labor warranty



ABS Premier Hydrocarbon Flammable Storage Freezer



Cat. No.	Description	
ABT-HC-FFP-14 	Premier Hydrocarbon Flammable Storage Freezer, 14 cu. ft., Exterior Dimensions (WxDxH): 23.625" x 24.375" x 73", 3 Amps, 1/3 HP	Call for Pricing
ABT-HC-FFP-17 	Premier Hydrocarbon Flammable Storage Freezer, 17 cu. ft., Exterior Dimensions (WxDxH): 30.75" x 28.625" x 67.75", 5.5 Amps, 1/2 HP	Call for Pricing
ABT-HC-FFP-20 	Premier Hydrocarbon Flammable Storage Freezer, 20 cu. ft., Exterior Dimensions (WxDxH): 30.75" x 29" x 74.625", 5.5 Amps, 1/2 HP	Call for Pricing

Manual Defrost Hazardous Location Upright Freezers

ABS Hazardous Location Upright Freezer

- Adjustable operating temperature range -15°C to -25°C
- Microprocessor temperature controller
- Solid swing door right hinged (not reversible), not equipped with plug, must be hardwired in conduit, six fixed shelves, magnetic door gasket for positive seal, heavy duty door handle, keyed door lock, manual defrost, leveling legs
- White textured cabinet and door, high density urethane foam cabinet and door insulation, natural hydrocarbon refrigerant (R290), 115V, 60Hz, ETL Listed, Meets NFPA and OSHA Guidelines for Hazardous Locations, Class 1 Division II, Group C and D.
- Two year parts and labor warranty



ABS Hazardous Location Upright Freezer		
Cat. No.	Description	
ABT-HC-EFP-14 	Hazardous Location Upright Freezer, 14 cu. ft., Exterior Dimensions (WxDxH): 23.625" x 24.375" x 73", 3 Amps, 1/3 HP	Call for Pricing
ABT-HC-EFP-17 	Hazardous Location Upright Freezer, 17 cu. ft., Exterior Dimensions (WxDxH): 30.75" x 28.625" x 67.75", 5.5 Amps, 1/2 HP	Call for Pricing
ABT-HC-EFP-20 	Hazardous Location Upright Freezer, 20 cu. ft., Exterior Dimensions (WxDxH): 30.75" x 29" x 74.625", 5.5 Amps, 1/2 HP	Call for Pricing

ABT-HC-EFP-17

Ultra-low Temperature Under Counter Freezers

K2 Scientific Ultra-low Temperature Under Counter Freezer

- Intelligent microprocessor digital LCD display, password protected
- Adjustable operating temperature range -25°C to -86°C
- Cabinet and ambient air temperature displays, adjustable temperature control, audible and visual high or low temperature alarms, power failure audible alarm, low battery audible alarm, sensor failure alarm, remote dry alarm contacts
- One solid external door, two internal doors, one stainless-steel shelf, adjustable in 1" inch increments, leveling legs, manual defrost, exterior and interior cabinet constructed of white powder-coated galvanized steel with PUF-VIP, high density insulation, CFC-Free refrigerant
- 0.50" temperature probe and data logger access port
- Each cabinet undergoes three quality control checks prior to shipping
- ISO: 9001:2015, CDC and VFC Compliant, EPA and SNAP Compliant
- Two-year parts, labor, or full replacement warranty



K2 Scientific Ultra-low Temperature Freezer		
Cat. No.	Description	List Price
K203ULT	Ultra-low Temperature Under Counter Freezer, Interior Dimensions (WxDxH): 12.6" x 19.29" x 24.02", Exterior Dimensions (WxDxH): 31.3" x 26.38" x 31.9", 3 cu. ft.	\$6,071.85

Ultra-low Temperature Under Counter Freezers

Haier Upright Ultra-low Temperature Under Counter Freezer

- Adjustable operating temperature range -40°C to -86°C
- Microprocessor temperature controller
- Front loading, two stainless steel inner doors, one shelf, high/low power failure, low battery and door ajar alarm, equipped with remote alarm function, port hole, start-up delay, RS-485 port, USB interface, manual defrost, LED display
- Auto-cascade hydrocarbon refrigerant, 120V, 60Hz, CE Certified
- Interior dimensions (WxDxH): 13" x 18.9" x 12.4"; Exterior (WxDxH): 20.9" x 25.2" x 31.7"
- Three year parts and labor warranty, plus additional five year compressor parts only warranty



Haier Upright Ultra-low Temperature Under Counter Freezer

Cat. No.	Description	List Price
DW-86L51J	Upright Ultra-low Temperature Under Counter Freezer, 1.8 cu. ft. (51L)	\$5,625.00

Haier Upright Ultra-low Temperature Under Counter Front Loading Freezer

- Adjustable operating temperature range -40°C to -86°C
- Microprocessor temperature controller
- Front loading, two stainless steel inner doors, one shelf, multiple fault alarms, two types of alarms: audible buzzer and flashing light alarm, standard lockable door equipped with four keys and has ability to add a padlock for added security, remote alarm, port hole, standard RS-485 port, USB interface, manual defrost, LED display
- 70mm super thick insulation layer design, aviation vacuum insulation material VIP, four layers of silicone seal, HC refrigerant, direct cooling, 115V, 60Hz
- Interior dimensions (WxDxH): 13" x 19" x 25"; Exterior (WxDxH): 30" x 26" x 32"
- Three year parts and labor warranty, plus additional five year compressor parts only warranty



Haier Upright Ultra-low Temperature Under Counter Front Loading Freezer

Cat. No.	Description	List Price
DW-86L100J	Upright Ultra-low Temperature Under Counter Front Loading Freezer, 3.5 cu. ft. (100L)	\$7,995.00

MTC Bio BioBucket™ Collapsible Bucket

- Usable with crushed ice
- Molded grip on base for pouring
- Attached handle for easy transport
- Inner lid access port for enhanced temperature retention
- Perfect for field use as an environmental sample collection and transport receptacle



BioBucket™ Collapsible Bucket

Cat. No.	Description	List Price
T583001	BioBucket Collapsible Lab Bucket - 5 Liters	\$54.00

Ultra-low Temperature Chest Freezers

K2 Scientific Ultra-low Temperature Chest Freezer

- Intelligent microprocessor digital LCD display, password protected
- Adjustable operating temperature range -25°C to -86°C
- Cabinet and ambient air temperature displays, adjustable temperature control, audible and visual high or low temperature alarms, power failure audible alarm, low battery audible alarm, sensor failure alarm, remote dry alarm contacts
- One lid, manual defrost, easy swivel casters, exterior and interior cabinet constructed of white powder-coated galvanized steel with PUF-VIP, high density insulation, CFC-Free refrigerant, UL listed
- 0.50" temperature probe and data logger access port
- Each cabinet undergoes three quality control checks prior to shipping
- cULus, ISO 9001:2015, CDC and VFC Compliant, EPA and SNAP compliant
- Two-year parts, labor, or full replacement warranty



K2 Scientific Ultra-low Temperature Chest Freezer

Cat. No.	Description	List Price
K205ULT	Ultra-low Temperature Chest Freezer, Interior Dimensions (WxDxH): 25" x 18" x 18", Exterior Dimensions (WxDxH): 33.5" x 28.88" x 40.13", 5 cu. ft.	\$5,331.02

Ultra-low Temperature Upright Freezers

K2 Scientific Ultra-low Temperature Upright Freezers

- Intelligent microprocessor digital LCD display, password protected
- Adjustable operating temperature range -50°C to -86°C
- Cabinet and ambient air temperature displays, adjustable temperature control, audible and visual high or low temperature alarms, power failure audible alarm, low battery audible alarm, sensor failure alarm, remote dry alarm contacts
- One external, two internal doors, three stainless-steel shelves are adjustable in 1" inch increments, manual defrost, easy swivel casters, exterior and interior cabinet constructed of white powder-coated galvanized steel with PUF-VIP, high density insulation, CFC-Free refrigerant
- 0.50" temperature probe and data logger access port
- Each cabinet undergoes three quality control checks prior to shipping
- cULus, ISO: 9001:2015, CDC and VFC Compliant, EPA and SNAP Compliant
- Two-year parts, labor, or full replacement warranty



K2 Scientific Ultra-low Temperature Upright Freezer

Cat. No.	Description	List Price
K210ULT	Ultra-low Temperature Upright Freezer, Interior Dimensions (WxDxH): 18" x 17.5" x 51.5", Exterior Dimensions (WxDxH): 25.5" x 27.5" x 77.753", 10 cu. ft.	\$ 8,428.85
K221ULT	Ultra-low Temperature Upright Freezer, Interior Dimensions (WxDxH): 28.5" x 22.5" x 51.5", Exterior Dimensions (WxDxH): 36.22" x 33" x 75.6", 21 cu. ft.	\$11,272.06
K226ULT	Ultra-low Temperature Upright Freezer, Interior Dimensions (WxDxH): 29" x 28" x 51.57", Exterior Dimensions (WxDxH): 36.13" x 38" x 77.63", 26 cu. ft.	\$13,680.31

Ultra-low Temperature Upright Freezers

ABS Ultra-low Temperature Laboratory Freezer

- Adjustable operating temperature range -50°C to -86°C
- Microprocessor temperature controller
- Single swing door with five insulated inner doors, four stainless steel shelves, 320-400 (2") box capacity (depending on model), four casters with locks, touch key pads with LED display, audible and visual alarms, programmable high and low alarms, battery backup
- Two year parts and labor warranty, plus an additional three year compressor parts only warranty

ABS Ultra-low Temperature Laboratory Freezer		
Cat. No.	Description	
ABT-230V-1786	Ultra-low Temperature Laboratory Freezer, Interior Dimensions (WxDxH): 23.4" x 23" x 50", Exterior Dimensions (WxDxH): 37.6" x 36.3" x 79.6", 17 cu. ft., 230V	Call for Pricing
ABT-115V-1786	Ultra-low Temperature Laboratory Freezer, Interior Dimensions (WxDxH): 23.4" x 23" x 50", Exterior Dimensions (WxDxH): 37.6" x 36.3" x 79.6", 17 cu. ft., 115V	Call for Pricing
ABT-230V-2186	Ultra-low Temperature Laboratory Freezer, Interior Dimensions (WxDxH): 29.1" x 23" x 50", Exterior Dimensions (WxDxH): 43.3" x 36.3" x 79.6", 21 cu. ft., 230V	Call for Pricing
ABT-115V-2186	Ultra-low Temperature Laboratory Freezer, Interior Dimensions (WxDxH): 29.1" x 23" x 50", Exterior Dimensions (WxDxH): 43.3" x 36.3" x 79.6", 21 cu. ft., 115V	Call for Pricing



ABS Ultra-low Temperature 25 Cu. Ft. Laboratory Freezer

- Adjustable operating temperature range -50°C to -86°C
- Microprocessor temperature controller
- Single swing door with five insulated inner doors, six stainless steel shelves, 480 (2") box capacity, four casters with locks, touch key pads with LED display, audible and visual alarms, programmable high and low alarms, battery backup
- Interior dimensions (WxDxH): 34.8" x 23" x 50", Exterior dimensions (WxDxH): 49" x 36.3" x 79.6"
- Two year parts and labor warranty, plus an additional three year compressor parts only warranty

ABS Ultra-low Temperature 25 Cu. Ft. Laboratory Freezer		
Cat. No.	Description	
ABT-230V-2586	Ultra-low Temperature Laboratory Freezer, 25 cu. ft., 230V	Call for Pricing



Benchmark Cool Cube Microtube and PCR Plate Cooler

- Maintains 0°C for 4 hours
- Holds microtubes and PCR plates, can be used as a PCR workstation
- Two-sided, made of durastar polymer
- Dimension (W x D x H) 5.6" x 5.6" x 2.5", 2 Year warranty

Cat. No.	Description	List Price
R-1000	Cool Cube Microtube and PCR Plate Cooler	\$148.73





Ultra-low Temperature Upright Freezers

Haier TwinCool Upright Ultra-low Temperature Freezer

- Microprocessor temperature controller, adjustable operating temperature range -50°C to -86°C, high-low temperature alarm, remote alarm contacts and battery backup
- Dual auto cascade compressors, three adjustable shelves, four inner doors, touchscreen display, hydrocarbon refrigerants and CFC-Free foam insulation, Energy Star; ST 115V 60Hz; SAT 220V 60Hz
- Five year parts and labor warranty, plus an additional ten year compressor parts only warranty





Haier TwinCool Upright Ultra-low Temperature Freezer		
Cat. No.	Description	List Price
DW-86L578ST/SAT 	TwinCool Upright Ultra-low Temperature Freezer, 20.5 cu. ft. (578L), Interior Dimensions (WxDxH): 24.4" x 28.2" x 51.6", Exterior Dimensions (WxDxH): 35.4" x 39.3" x 78"	\$21,995.00
DW-86L728ST/SAT 	TwinCool Upright Ultra-low Temperature Freezer, 25.7 cu. ft. (728L), Interior Dimensions (WxDxH): 30.2" x 28.2" x 51.6", Exterior Dimensions (WxDxH): 41.2" x 39.3" x 78"	\$23,895.00

Haier TwinCool Upright Frequency Conversion Freezer

- Microprocessor temperature controller, adjustable operating temperature range -40°C to -86°C, multiple alarms, high-low temperature alarm, remote alarm contacts and battery backup
- Magnetic filter screen, two portholes, USB interface, adjustable feet casters, manual defrost, three adjustable shelves, four inner doors, 10.1" LCD touchscreen, hydrocarbon refrigerants and foam material LBA, 100-230V-60Hz
- Five year parts and labor warranty, plus an additional ten year compressor parts only warranty



Haier TwinCool Upright Frequency Conversion Freezer		
Cat. No.	Description	List Price
86L578BPST 	TwinCool Upright Frequency Conversion Freezer, 20.4 cu. ft. (578L), Interior Dimensions (WxDxH): 24.4" x 28.2" x 51.6", Exterior Dimensions (WxDxH): 35.2" x 39.3" x 78"	\$22,995.00
86L728BPST 	TwinCool Upright Ultra-low Temperature Freezer, 25.7 cu. ft. (728L), Interior Dimensions (WxDxH): 30.2" x 28.2" x 51.6", Exterior Dimensions (WxDxH): 41.2" x 39.3" x 78"	\$24,895.00

MTC Bio FlipTop™ Carboard Freezer Box

- Attached hinged lids. 3" boxes - 5.25" x 5.25" inch footprint, tubes up to 12.5mm diameter
- Standard size for existing racks, for 81 or 100 tubes, alpha-numeric coding



MTC Bio FlipTop™ Carboard Freezer Box		
Cat. No.	Description	List Price
R3700	FlipTop™ Carboard Freezer Box w/Attached Hinged Lid, 3", 100-place, white, 50/cs	\$148.73
R3781	FlipTop™ Carboard Freezer Box w/Attached Hinged Lid, 3", 81-place, white, 50/cs	\$148.73

Ultra-low Temperature Upright Freezers

Haier -86° Upright TwinCool Frequency Conversion Freezer

- Microprocessor controller, temperature range -40° to -86°C
- 10.1" LCD touch screen, three shelves and four inner doors, multiple alarms, manual defrost, magnetic filter screen
- Hydrocarbon refrigerant and foam material LBA, two portholes, USB interface, adjustable feet, casters, interior dimensions (W x D x H) 24.4" x 28.2" x 51.6", exterior dimensions (W x D x H) 35.2" x 39.3" x 78.0", 100-230V, 50/60 Hz
- Five year parts and labor warranty, plus an additional ten year compressor parts only



Haier -86° Upright TwinCool Frequency Conversion Freezer



Cat. No.	Description	List Price
DW-86L828BPST	TwinCool Frequency Conversion Freezer, 20.4 cu. ft. (578L), Twin Cooled	\$26,895.00

Haier Smart Frequency Conversion Upright Freezer

- Microprocessor temperature controller, adjustable operating temperature range -40°C to -86°C, multiple compressor speed, multiple alarms
- Wireless monitoring connectivity, two portholes, standard equipped with key lock, padlock and electromagnetic lock, adjustable feet casters, manual defrost, three adjustable shelves, four inner doors, 10" LCD smart full size touchscreen, hydrocarbon refrigerant and optimized insulation double foaming for both inner and outer doors, Energy Star, 100-230V, 50/60Hz
- Five year parts and labor warranty, plus an additional ten year compressor parts only warranty



Haier Smart Frequency Conversion Upright Freezer

Cat. No.	Description	List Price
86L579BPT 	Smart Frequency Conversion Upright Freezer, 20.5 cu. ft. (579L), Interior Dimensions (WxDxH): 24.4" x 28.2" x 51.6", Exterior Dimensions (WxDxH): 35.2" x 39.3" x 78"	\$19,995.00
86L729BPT 	Smart Frequency Conversion Upright Freezer, 25.7 cu. ft. (729L), Interior Dimensions (WxDxH): 30.2" x 28.2" x 51.6", Exterior Dimensions (WxDxH): 41.2" x 39.3" x 78.0"	\$21,895.00
86L959BPT 	Smart Frequency Conversion Upright Freezer, 33.9 cu. ft. (959L), Interior Dimensions (WxDxH): 40.0" x 28.2" x 51.5", Exterior Dimensions (WxDxH): 51" x 39.3" x 78"	\$24,995.00

Heathrow Arctic Squares® Cryogenic Tube Storage Boxes

Cat. No.	Description	List Price
HS23300D	PC 100-Place, Blue	\$ 64.28
HS23325A	PC 25-Place, Red	\$ 83.95
HS23381B	PC 81-Place, Assorted	\$ 64.22
HS2864	4x4 Freezer Rack, Stainless Steel, 2", Steel	\$299.29



Ultra-low Temperature Upright Freezers

Haier Ultra Low Temperature Smart Frequency Conversion Freezer

- Microprocessor controller, temperature range -40° to -86°C
- Variable compressor speed, 10" LCD smart full size touch screen, three shelves and four inner doors, standard equipped with key lock, padlock and electromagnetic lock, multiple alarms, manual defrost, magnetic filter screen, wireless monitoring connectivity
- Hydrocarbon refrigerant and optimized insulation double foaming for both inner and outer doors, two portholes, adjustable feet, casters, interior dimensions (W x D x H) 34.3" x 28.2" x 51.6", exterior dimensions (W x D x H) 45.1" x 39.3" x 78.0", 208-230V, 50/60 Hz
- Five year parts and labor warranty, plus an additional ten year compressor parts only



Haier Ultra Low Temperature Smart Frequency Conversion Freezer

Cat. No.	Description	List Price
DW-86L829BPT	Ultra Low Temperature Smart Frequency Conversion Freezer, 29.2 cu. ft. (829L)	\$22,995.00

Energy Saving Ultra-low Temperature Upright Freezers

Haier Upright Energy Saving Ultra-low Temperature Freezer

- Microprocessor temperature controller, adjustable operating temperature range -40°C to -86°C, multiple alarm system, standard door lock, four keys with ability to add padlock, remote alarm access port
- Dual compressor system, three adjustable shelves, two stainless steel inner doors, LED display, USB port, manual defrost, two foot locks and four casters, 70mm super thick insulation layer design, aviation vacuum insulation material VIP, four layers of silicone seal, Energy Star, 12 cu. ft. (338L)
- Interior dimensions (WxDxH): 18.3" x 24.8" x 45.9", Exterior dimensions (WxDxH): 37.2" x 35.2" x 72.7"
- Three year parts and labor warranty, plus an additional five year compressor parts only warranty



Haier Upright Energy Saving Ultra-low Temperature Freezer

Cat. No.	Description	List Price
DW-86L338J	Upright Energy Saving Ultra-low Temperature Freezer, 115V, 60 Hz	\$11,996.00
DW-86L338JA	Upright Energy Saving Ultra-low Temperature Freezer, 220V, 60 Hz	\$11,996.00

Heathrow Thin Film Polypropylene Cryogenic Freezer Boxes

Cat. No.	Description	List Price
HS120370	1.5/2mL, 81-Place, White	\$90.30
HS120371	1.5/2mL, 81-Place, Blue	\$90.30
HS120372	1.5/2mL, 81-Place, Green	\$90.30
HS120373	1.5/2mL, 81-Place, Purple	\$90.30



Energy Saving Ultra-low Temperature Upright Freezers

Haier Energy Saving Ultra-low Temperature Chest Freezer

- Microprocessor temperature controller, adjustable operating temperature range -40°C to -86°C, multiple alarm system, passcode controlled, remote alarm access port,
- Dual compressor system, one single inner, four outer door seals, LED display, USB port, manual defrost, R290 1st stage, R290-R170 mix 2nd stage refrigerants, white-coated cold plate steel interior and exterior, VIP plus and CFC-free foamed polyurethane insulation, 220V 60Hz, 14.8 cu. ft. (420L)
- Interior dimensions (WxDxH): 53.8" x 18.2" x 25.7", Exterior dimensions (WxDxH): 83.9" x 34.3" x 40.2"
- Three year parts and labor warranty, plus an additional five year compressor parts only warranty



Haier Upright Energy Saving Ultra-low Temperature Freezer

Cat. No.	Description	List Price
DW-86W420JA	Energy Saving Ultra-low Temperature Chest Freezer, 14.8 cu. ft. (420L)	\$12,995.00

Haier Upright Double Door Energy Saving Ultra-low Temperature Freezer

- Microprocessor temperature controller, adjustable operating temperature range -40°C to -86°C, multiple alarm system, standard door lock, four keys with ability to add padlock, passcode controlled, remote alarm access port
- Dual compressor system, three adjustable shelves, four inner doors, LED display, USB port, manual defrost, 70mm super thick insulation layer design, aviation vacuum insulation material VIP, four layers of silicone seal, two foot locks and four casters, Energy Star, 220V 60Hz, 17.3 cu. ft. (490L)
- Interior dimensions (WxDxH): 23.2" x 24.8" x 51.6", Exterior dimensions (WxDxH): 34.4" x 35.4" x 78" (without all-direction casters)
- Three year parts and labor warranty, plus an additional five year compressor parts only warranty



Haier Upright Double Door Energy Saving Ultra-low Temperature Freezer

Cat. No.	Description	List Price
DW-86L490JA	Upright Double Door Energy Saving Ultra-low Temperature Freezer, 17.3 cu. ft. (490L)	\$13,995.00

Heathrow Cardboard Tube Storage Boxes and Lids

Cat. No.	Description	List Price
HS2860M	Cardboard Tube Storage Box and Lid for 15 and 50mL Tubes (no insert), White	\$ 79.89
HS2860P	Cardboard Tube Storage Box Partition/Divider 16 Well 50mL Tubes, White	\$ 61.31
HS2860T	Cardboard Tube Storage Box Partition/Divider 36 Well 15mL Tubes, White	\$ 69.02
120519	Cardboard Cryogenic Tube Box, 25 place 5x5 format, for 1.5/2mL tubes, 25/pk	\$550.65
HS120220	Cardboard Cryogenic Freezer Box, 0.2mL Tube, White	\$ 91.77
HS120221	Cardboard Cryogenic Freezer Box, 0.5mL Tube, White	\$ 91.77

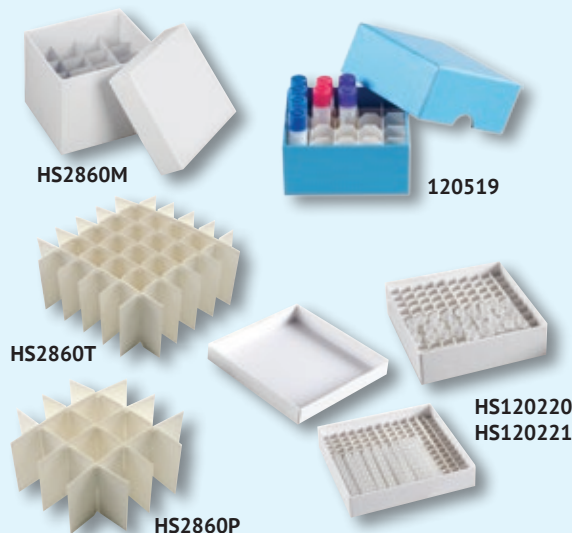

Energy Saving Ultra-low Temperature Upright Freezers



Haier Upright Energy Saving Ultra-low Temperature Freezer

- Microprocessor temperature controller, adjustable operating temperature range -40°C to -86°C, multi-alarm system, passcode controlled, remote alarm access port
- Dual compressor system, three adjustable shelves, four inner doors, 16 rack, 40000 x 2mL tube capacity, LED display, USB port, manual defrost, R290 1st stage, R170 2nd stage refrigerants, one single inner, four outer door seals, cold plate steel exterior, zinc-plated steel interior, both white coated; VIP plus and CFC-Free foamed polyurethane insulation, Energy Star
- Three year parts and labor warranty, plus an additional five year compressor parts only warranty



ALL MEET
INSTANT REBATE
ELIGIBILITY
REQUIREMENTS

Haier Upright Energy Saving Ultra-low Temperature Freezer

Cat. No.	Description	List Price
DW-86L578J 	Upright Energy Saving Ultra-low Temperature Freezer, 20 cu. ft., 115V, 60 Hz, Interior Dimensions (WxDxH): 24.4" x 28.2" x 51.6", Exterior Dimensions (WxDxH): 35.4" x 38.6" x 77.2" without all-direction casters	\$14,995.00
DW-86L728J 	Upright Energy Saving Ultra-low Temperature Freezer, 26 cu. ft. (728L), 115V, 60 Hz, Interior Dimensions (WxDxH): 30.2" x 28.2" x 51.6", Exterior Dimensions (WxDxH): 41.0" x 38.6" x 78"	\$16,995.00
DW-86L828JA 	Upright Energy Saving Ultra-low Temperature Freezer, 29 cu. ft. (828L), 220V, 60 Hz, Interior Dimensions (WxDxH): 34.3" x 28.2" x 51.5", Exterior Dimensions (WxDxH): 45.1" x 38.6" x 78" without all-direction casters	\$17,995.00

Haier Upright Energy Saving Ultra-low Temperature Freezer

Cat. No.	Description	List Price
DW-86L578JA	Upright Energy Saving Ultra-low Temperature Freezer, 20 cu. ft., 220V, 60 Hz, Interior Dimensions (WxDxH): 24.4" x 28.2" x 51.6", Exterior Dimensions (WxDxH): 35.4" x 38.6" x 77.2" without all-direction casters	\$14,995.00
DW-86L728JA	Upright Energy Saving Ultra-low Temperature Freezer, 26 cu. ft. (728L), 220V, 60 Hz, Interior Dimensions (WxDxH): 30.2" x 28.2" x 51.6", Exterior Dimensions (WxDxH): 41.0" x 38.6" x 78"	\$16,995.00

Heathrow Polypropylene Corrugated Freezer Boxes

Cat. No.	Description	List Price
HS120376	Cryogenic, 1.5/2mL, 81-Place, Blue	\$ 84.70
HS120379	Cryogenic, 0.2mL, 144-Place, Natural	\$123.86
HS120383	Cryogenic, 0.5mL, 81-Place, Natural	\$123.86
HS120387	Cryogenic, 5mL, 25-Place, Natural	\$123.86
HS120388	Cryogenic, 5mL, 25-Place, Blue	\$123.86
HS120391	Cryogenic, 15mL, 36-Place, Natural	\$150.38
HS120392	Cryogenic, 15mL, 36-Place, Blue	\$150.38
HS120428	100-Place, Squat Vial, Natural	\$149.09
HS120262	Cryogenic, 1.5/2mL, 81-Place, Natural	\$ 80.59
HS120366	Cryogenic, 50mL, 16-Place, Natural	\$145.63
HS120367	Cryogenic, 50mL, 16-Place, Blue	\$145.63

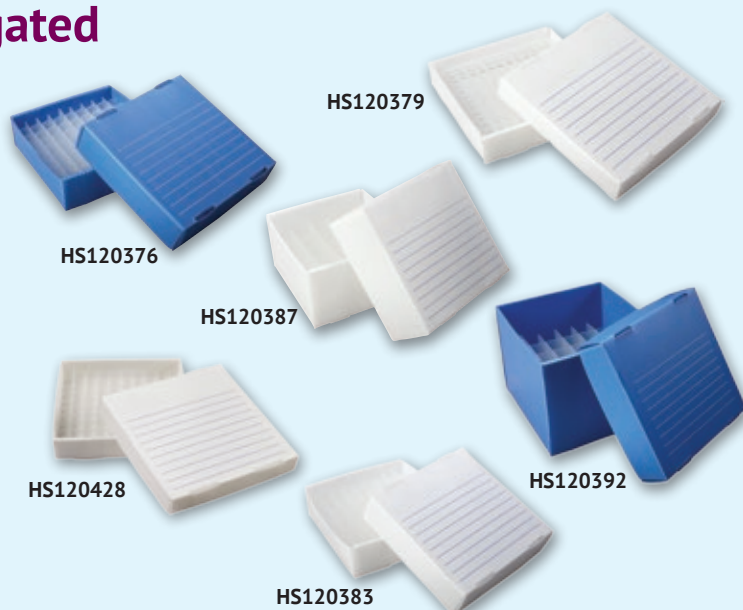

Thermo Scientific TSX Universal Series Ultra-low Temperature Freezers

Greener by design™

We leverage the power of innovation to positively contribute to a healthier world, which includes reducing the environmental impact of our products and packaging—from design to end of life. By incorporating environmental sustainability principles into each design step, we can better understand and reduce the environmental impact of our products early in the design process, helping to ultimately deliver on our commitment to achieve net-zero emissions by 2050 while helping customers advance their sustainability goals.

Greener by design: In 2022, we elevated our Design for Sustainability (DfS) approach, positioning our R&D organization to expand, accelerate, and standardize how environmental considerations are embedded into product development. Our strategy focuses on five key impact areas: less hazardous, less waste, more energy efficient, responsibly packaged, and extended life. (Demonstrated in Figure 1)

ENERGY STAR–certified: Built with an unwavering commitment to sustainability, the next-generation TSX Universal ULTs are ENERGY STAR certified, with our largest size using 43% less energy than the allowed amount.

ACT. Transparency in sustainability: We believe it should be easy to make informed purchasing decisions when looking for more sustainable products. By participating in the ACT label program, run by the non-profit organization My Green Lab, we can provide easy-to-use information about our ULTs' environmental impact.



33%
Improvement in energy efficiency over previous generation TSX Series ULT.

100%
All TSX Universal ULTs beat today's ENERGY STAR criteria by wide margins and positioned to meet tightening requirements in the future.

100%
All TSX Universal Series ULTs are My Green Lab ACT labeled.

Figure 1: TSX Universal Series ULT freezers – Greener by design approach



Less hazardous

We use natural refrigerants and insulation with extremely low GWP & ODP levels, far lower than current regulatory requirements.



Less waste

Asheville, NC, is a Zero-Waste to Landfill site and our lab freezers are manufactured with 60-70% recycled steel.



More energy efficient

All ULTs are ENERGY STAR certified, providing substantial energy savings.



Responsibly packaged

We use locally sourced and 100% by-weight recycled corrugate packaging and manufacture regionally to reduce transport emissions.



Extended life

Our ULTs offer a 12-year industry leading warranty, helping minimize the production, shipping, and disposal of units each year.

Thermo Scientific TSX Universal Series Ultra-low Temperature Freezers

Cat. No.	Capacity cu. ft. (liters)	Rack capacity (2" boxes)	Electrical	Plug	Shelves	Door Style	Interior Dimensions H x W x D in (cm)	Exterior Dimensions H x W x D in (cm)
TSX40086FA	19.4 (549)	16 (400)	100-230V 50/60 Hz	Country specific (see table for options)	4 shelves (3 Adjustable)	Outer (1) Inner (2)	28.3 x 23.1 x 51.2 in. (71.9 x 58.8 x 130.1)	37.6 x 28.3 x 78 in. (95.5 x 71.9 x 198.1)
TSX50086FA	24.1 (682)	20 (500)					28.3 x 28.8 x 51.2 in. (71.9 x 73.0 x 130.1)	37.6 x 34.0 x 78 in. (95.5 x 86.4 x 198.1)
TSX60086FA	28.8 (816)	24 (600)					28.3 x 34.4 x 51.2 in. (71.9 x 87.3 x 130.1)	37.6 x 34.0 x 78 in. (95.5 x 86.4 x 198.1)
TSX70086FA	33.5 (949)	28 (700)					28.3 x 40.1 x 51.2 in. (71.9 x 101.9 x 130.1)	37.6 x 45.2 x 78 in. (95.5 x 114.8 x 198.1)

TSX Universal ULTs offer a variety of options that can be customized to your application needs;

Versatile and durable storage

- 4 sizes
- 2 inner doors / (5 door option)
- Adjustable shelves
- High density footprint
- Stainless steel shelves
- Extra large capacity
- 7 zone gasket design
- Vacuum insulation panels
- Cold rolled steel cabinet
- Onboard diagnostics
- Optional:
 - 100s of rack options
 - Stainless steel interiors

Compliance and security

- UL 61010, CE, ISO 13485
- ISO 5.5 Cleanroom†
- Factory acceptance reports
- Calibration certificates
- Event and temperature logs
- Settings security
- Back-up battery
- Optional:
 - IQ/OQ documents
 - Electronic locks
 - LN₂ and CO₂ back-up systems
 - Status lights

Ergonomics and convenience

- Customizable display
- Eye level, high contrast large text display
- Automatic pressure relief
- Frost management system
- Multiple access ports
- Easy roll casters
- Easy to clean surfaces
- Full 7" capacitive touch screen

† Test according to ISO 14644-14 and designated as ISO Class 5.5; operational; 0.1 µm, 0.2 µm, 0.3 µm, 0.5 µm, 1.0 µm.

Thermo Scientific 400 Box Capacity TSX Universal Ultra-low Temperature Freezer		
Cat. No.	Description	List Price
TSX40086FA	Universal Ultra-low Temperature Freezer, Operating Temperature Range -50°C to -86°C, 100-230V, 50/60 Hz	\$26,233.00
TSX40086FALB	Universal Ultra-low Temperature Freezer, Operating Temperature Range -50°C to -86°C, Illumination Kit, 100-230V, 50/60 Hz	\$26,942.00
TSX40086FARAK	Universal Ultra-low Temperature Freezer, Operating Temperature Range -50°C to -86°C, 2 Shelves of Sliding Drawer Racks With 2" Boxes, 100-230V, 50/60 Hz	\$27,461.00
TSX40086FARAKCO	Universal Ultra-low Temperature Freezer, Operating Temperature Range -50°C to -86°C, 2 Shelves of Sliding Drawer Racks With 2" Boxes and Factory-installed CO2 Back-up System, 100-230V, 50/60 Hz	\$29,580.00
TSX40086FARAKHID	Universal Ultra-low Temperature Freezer, Operating Temperature Range -50°C to -86°C, 2 Shelves of Sliding Drawer Racks With 2" Boxes and Factory-installed Access Card Option, 100-230V, 50/60 Hz	\$27,571.00
TSX40086FARAKLB	Universal Ultra-low Temperature Freezer, Operating Temperature Range -50°C to -86°C, 2 Shelves of Sliding Drawer Racks With 2" Boxes, Illumination Kit, 100-230V, 50/60 Hz	\$27,931.00
TSX40086FARAKLN	Universal Ultra-low Temperature Freezer, Operating Temperature Range -50°C to -86°C, 2 Shelves of Sliding Drawer Racks With 2" Boxes and Factory-installed LN2 Back-up System, 100-230V, 50/60 Hz	\$29,580.00



Learn how to get Instant Rebates on Energy-Efficient Lab Cold Storage Equipment on page 37!

Thermo Scientific 500 Box Capacity TSX Universal Ultra-low Temperature Freezer		
Cat. No.	Description	List Price
TSX50086FA	Universal Ultra-low Temperature Freezer, Operating Temperature Range -50°C to -86°C, 100-230V, 50/60 Hz	\$28,249.00
TSX50086FALB	Universal Ultra-low Temperature Freezer, Operating Temperature Range -50°C to -86°C, Illumination Kit, 100-230V, 50/60 Hz	\$28,977.00
TSX50086FARAK	Universal Ultra-low Temperature Freezer, Operating Temperature Range -50°C to -86°C, 2 Shelves of Sliding Drawer Racks With 2" Boxes, 100-230V, 50/60 Hz	\$29,964.00
TSX50086FARAKCO	Universal Ultra-low Temperature Freezer, Operating Temperature Range -50°C to -86°C, 2 Shelves of Sliding Drawer Racks With 2" Boxes and Factory-installed CO2 Back-up System, 100-230V, 50/60 Hz	\$31,984.00
TSX50086FARAKHID	Universal Ultra-low Temperature Freezer, Operating Temperature Range -50°C to -86°C, 2 Shelves of Sliding Drawer Racks With 2" Boxes and Factory-installed Access Card Option, 100-230V, 50/60 Hz	\$29,970.00
TSX50086FARAKLB	Universal Ultra-low Temperature Freezer, Operating Temperature Range -50°C to -86°C, 2 Shelves of Sliding Drawer Racks With 2" Boxes, Illumination Kit, 100-230V, 50/60 Hz	\$30,433.00
TSX50086FARAKLN	Universal Ultra-low Temperature Freezer, Operating Temperature Range -50°C to -86°C, 2 Shelves of Sliding Drawer Racks With 2" Boxes and Factory-installed LN2 Back-up System, 100-230V, 50/60 Hz	\$31,984.00

**ALL MEET
INSTANT REBATE
ELIGIBILITY
REQUIREMENTS**

Thermo Scientific 600 Box Capacity TSX Universal Ultra-low Temperature Freezer		
Cat. No.	Description	List Price
TSX60086FA	Universal Ultra-low Temperature Freezer, Operating Temperature Range -50°C to -86°C, 100-230V, 50/60 Hz	\$30,265.00
TSX60086FALB	Universal Ultra-low Temperature Freezer, Operating Temperature Range -50°C to -86°C, Illumination Kit, 100-230V, 50/60 Hz	\$31,127.00
TSX60086FARAK	Universal Ultra-low Temperature Freezer, Operating Temperature Range -50°C to -86°C, 2 Shelves of Sliding Drawer Racks With 2" Boxes, 100-230V, 50/60 Hz	\$31,838.00
TSX60086FARAKCO	Universal Ultra-low Temperature Freezer, Operating Temperature Range -50°C to -86°C, 2 Shelves of Sliding Drawer Racks With 2" Boxes and Factory-installed CO2 Back-up System, 100-230V, 50/60 Hz	\$34,987.00
TSX60086FARAKHID	Universal Ultra-low Temperature Freezer, Operating Temperature Range -50°C to -86°C, 2 Shelves of Sliding Drawer Racks With 2" Boxes and Factory-installed Access Card Option, 100-230V, 50/60 Hz	\$32,374.00
TSX60086FARAKLB	Universal Ultra-low Temperature Freezer, Operating Temperature Range -50°C to -86°C, 2 Shelves of Sliding Drawer Racks With 2" Boxes, Illumination Kit, 100-230V, 50/60 Hz	\$31,831.00
TSX60086FARAKLN	Universal Ultra-low Temperature Freezer, Operating Temperature Range -50°C to -86°C, 2 Shelves of Sliding Drawer Racks With 2" Boxes and Factory-installed LN2 Back-up System, 100-230V, 50/60 Hz	\$34,987.00

**ALL MEET
INSTANT REBATE
ELIGIBILITY
REQUIREMENTS**

CoolCaddy™ PCR Workstation

- Keeps your reagents and samples cool, on the lab bench, without using crushed ice.
- Store your CoolCaddy overnight in any standard freezer and it's ready to hold temperature between 0° and 1°C for up to 5 hours.
- Capacity: 8.3 x 6.8 x 1.8"
 - 1.5/2.0mL Microtubes: 9 Tubes
 - 2.0mL Cryotubes: 8 Tubes
 - 0.5mL Microtubes: 5 Tubes
 - PCR Plates: 1 Plate
 - PCR Tubes: 96 Tubes or 12 Strips
 - Reservoirs: 1 x 50mL Reservoir



Cat. No.	Description	List Price
R4015	CoolCaddy™ PCR Workstation	\$148.74

Thermo Scientific 700 Box Capacity TSX Universal Ultra-low Temperature Freezer		
Cat. No.	Description	List Price
TSX70086FA	Universal Ultra-low Temperature Freezer, Operating Temperature Range -50°C to -86°C, 100-230V, 50/60 Hz	\$33,828.00
TSX70086FALB	Universal Ultra-low Temperature Freezer, Operating Temperature Range -50°C to -86°C, Illumination Kit, 100-230V, 50/60 Hz	\$37,727.00
TSX70086FARAK	Universal Ultra-low Temperature Freezer, Operating Temperature Range -50°C to -86°C, 2 Shelves of Sliding Drawer Racks With 2" Boxes, 100-230V, 50/60 Hz	\$36,218.00
TSX70086FARAKCO	Universal Ultra-low Temperature Freezer, Operating Temperature Range -50°C to -86°C, 2 Shelves of Sliding Drawer Racks With 2" Boxes and Factory-installed CO2 Back-up System, 100-230V, 50/60 Hz	\$37,928.00
TSX70086FARAKHID	Universal Ultra-low Temperature Freezer, Operating Temperature Range -50°C to -86°C, 2 Shelves of Sliding Drawer Racks With 2" Boxes and Factory-installed Access Card Option, 100-230V, 50/60 Hz	\$35,916.00
TSX70086FARAKLB	Universal Ultra-low Temperature Freezer, Operating Temperature Range -50°C to -86°C, 2 Shelves of Sliding Drawer Racks With 2" Boxes, Illumination Kit, 100-230V, 50/60 Hz	\$36,468.00
TSX70086FARAKLN	Universal Ultra-low Temperature Freezer, Operating Temperature Range -50°C to -86°C, 2 Shelves of Sliding Drawer Racks With 2" Boxes and Factory-installed LN2 Back-up System, 100-230V, 50/60 Hz	\$37,928.00

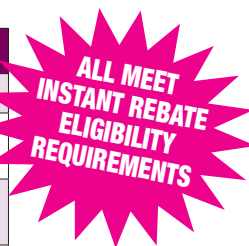

TSX Universal Ultra-low Temperature FDA Class II Freezers

TSX Universal Ultra-low Temperature FDA Class II Freezers		
Cat. No.	Description	List Price
TSX40086LA	Universal Ultra-low Temperature FDA Class II Freezer, 400 Box Capacity, Operating Temperature Range -50°C to -86°C, 100-230V, 50/60 Hz	\$28,856.30
TSX50086LA	Universal Ultra-low Temperature FDA Class II Freezer, 500 Box Capacity, Operating Temperature Range -50°C to -86°C, 100-230V, 50/60 Hz	\$31,073.90
TSX60086LA	Universal Ultra-low Temperature FDA Class II Freezer, 600 Box Capacity, Operating Temperature Range -50°C to -86°C, 100-230V, 50/60 Hz	\$33,291.50
TSX70086LA	Universal Ultra-low Temperature FDA Class II Freezer, 700 Box Capacity, Operating Temperature Range -50°C to -86°C, 100-230V, 50/60 Hz	\$37,210.80



TSX Universal Ultra-low Temperature Freezer Accessories

TSX Universal Ultra-low Temperature FDA Class II Freezers					
Cat. No.	Description	List Price	Cat. No.	Description	List Price
COTSXU	CO ₂ Backup TSXU, Factory	\$3,300.00	FCOTSXU	Field LN ₂ Backup TSXU	\$3,860.00
LNTSXU	LN ₂ Backup TSXU, Factory	\$3,300.00	FLNTSXU	Field CO ₂ Backup TSXU	\$3,910.00
ELTSXU	TSXU Factory-Installed access key option; Card access w/five key cards	\$1,160.00	FELTSXU	Access Card Option TSXU, Field	\$1,420.00

Freezer Racks

Cat. No.	Description	Capacity (boxes)	Dimensions (D x H x W) inches	List Price
Stainless Steel Side Access Racks with Handle for Upright Freezers for Standard 2" Boxes				
RK-332	Upright 3 x 3 freezer rack	9	16 7/8 x 6 5/8 x 5 1/2	\$103.71
RK-342	Upright 3 x 4 freezer rack	12	16 7/8 x 8 7/8 x 5 1/2	\$136.83
RK-442	Upright 4 x 4 freezer rack	16	22 3/16 x 8 7/8 x 5 1/2	\$183.12
RK-452	Upright 4 x 5 freezer rack	20	22 3/16 x 11 x 5 1/2	\$237.18
RK-462	Upright 4 x 6 SS freezer rack	24	22 3/16 x 12 3/8 x 5 1/2	\$256.53
RK-542	Upright 5 x 4 SS freezer rack	20	27 5/16 x 8 7/8 x 5 1/2	\$260.44
RK-552	Upright 5 x 5 SS freezer rack	25	27 5/16 x 11 x 5 1/2	\$264.35

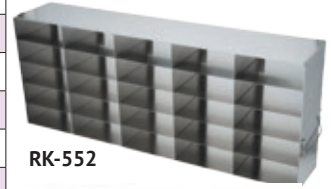
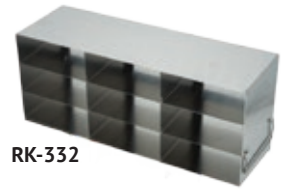

Stainless Steel Drawer Racks for Upright Freezers for Standard 2" Boxes

RKD-332	Upright Drawer 3 x 3 freezer rack w/handle	9	16 3/4 x 7 1/8 x 5 1/2	\$136.57
RKD-342	Upright Drawer 3 x 4 freezer rack w/handle	12	16 3/4 x 9 7/16 x 5 1/2	\$176.53
RKD-442	Upright Drawer 4 x 4 freezer rack w/handle	16	22 5/16 x 9 7/16 x 5 1/2	\$223.57
RKD-452	Upright Drawer 4 x 5 freezer rack	20	22 7/16 x 11 13/16 x 5 1/2	\$232.71
RKD-462	Upright Drawer 4 x 6 freezer rack w/handle	24	22 5/16 x 14 1/8 x 5 1/2	\$254.19
RKD-542	Upright Drawer 5 x 4 freezer rack	20	27 x 9 7/16 x 5 1/2	\$308.73
RKD-552	Upright Drawer 5 x 5 freezer rack	25	27 x 11 13/16 x 5 1/2	\$284.25
DFDR-50LT	Upright Drawer Rack for 50 mL Centrifuge Tubes	78 Tubes	22 3/16 x 5 1/2 x 9 15/16	\$212.51
DFDR-15LT	Upright Drawer Rack for 15 mL Centrifuge Tubes	160 Tubes	22 3/16 x 5 1/2 x 9 15/16	\$220.91

Stainless Steel Racks for Chest Freezers & LN2 Tanks for Standard 2" Boxes

Cat. No.	Description	Capacity (boxes)	Dimensions (H x W x D) inches	List Price
DFVR-12-2	Chest style / LN2 Vertical 12 place rack with handle	12	26 5/8 x 5 5/8 x 5 1/2	\$125.92
DFVR-13-2	Chest style / LN2 Vertical 13 place rack	13	28 1/2 x 5 5/8 x 5 1/2	\$136.57



Stainless Steel Racks with Handle for Upright Freezers for Standard 3" Boxes

Cat. No.	Description	Capacity (boxes)	Dimensions (D x W x H) inches	List Price
RK-433	Upright 4 x 3 freezer rack	12	22 3/16 x 5 1/2 x 9 3/8	\$135.70
RKD-433	Upright Drawer 4 x 3 Freezer rack	12	22 5/16 x 5 1/2 x 10 1/16	\$157.13

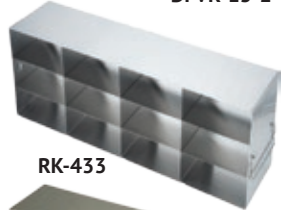

Stainless Steel Rack with Handle for Upright Freezers for Mixed Storage of 2", 3", and 3.75" Standard Boxes

Cat. No.	Description	Capacity (boxes)	Dimensions (L x H x W) inches	List Price
RK-412	Upright freezer rack		22 1/8 x 12 3/8 x 5 1/2	\$127.85



Stainless Steel Racks for Upright Freezers for Plates, Includes Locking Rod

Cat. No.	Description	Capacity (boxes)	Dimensions (D x W x H) inches	List Price
UFMP-509L	Rack for 96/384-well Microtiter plates	70 Plates with Lids, 80 without Lids	18 13/16 x 5 1/2 x 9 3/16	\$148.53
UFMP-609L	Rack for 96/384-well Microtiter plates	84 Plates with Lids, 96 without Lids	22 1/2 x 5 1/2 x 9 3/16	\$173.14
RKDP-66L	Rack for 96-Deep-Well Microtiter Plates. For Speciality Tube Racks (Matrix, Fluidx, Micronic) - H: 9/16" to 1 3/4" (14.4 to 44.32mm)	36 Plates	22 1/2 x 5 1/2 x 11 1/16	\$245.45

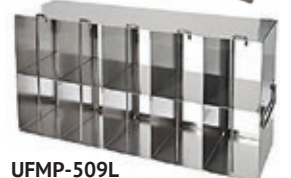

5mL Snap Cap MacroTubes®

- Compatible with standard equipment
- Easy open flip top
- Syringe port in cap
- Exceptional clarity
- Dual graduations at 0.2mL and 0.5mL

5mL Snap Cap MacroTubes®		
Cat. No.	Description	List Price
T2500	5mL MacroTube®, non-sterile, 2 bags of 100 tubes, 200/pk	\$44.50
T2520	5mL MacroTube®, sterile, 10 bags of 20 tubes, 200/pk	\$54.00
T2500-B	5mL MacroTube®, non-sterile, 2 bags of 100 tubes, blue tinted, 200/pk	\$44.50
T2500-G	5mL MacroTube®, non-sterile, 2 bags of 100 tubes, green tinted, 200/pk	\$44.50
T2500-R	5mL MacroTube®, non-sterile, 2 bags of 100 tubes, red tinted, 200/pk	\$44.50
T2500-Y	5mL MacroTube®, non-sterile, 2 bags of 100 tubes, yellow tinted, 200/pk	\$44.50
T2500-OB	5mL MacroTube®, non-sterile, 2 bags of 100 tubes, opaque black tint, 200/pk	\$44.50
T2500-AST	5mL MacroTube®, non-sterile, 4 bags of 50 tubes, assorted colors, 200/pk	\$44.50



5mL Screw Cap MacroTubes®

- Compatible with standard equipment
- Centrifuge up to 25,000xg
- Dual graduations at 0.2mL and 0.5mL
- RNase, DNase and Pyrogen free
- Exceptional clarity

5mL Screw Cap MacroTubes®		
Cat. No.	Description	List Price
T2540	5mL Screw-cap MacroTube®, sterile, w/attached screw caps in foam racks, 500/cs	\$112.35
T2540-OB	5mL Screw-cap MacroTube®, sterile, w/attached screw caps in foam racks, Opaque Black, 500/cs	\$129.50
T2535	5mL Screw-cap MacroTube®, sterile, w/screw caps, packed in bags of 100	\$105.00
T2530	5mL Screw-cap MacroTube®, non-sterile, w/screw caps packed separately, 500/cs	\$ 99.00
T2500-SK	5mL MacroTube® Starter Kit. Includes: 200 sterile snap-cap tubes (C2520), 200 sterile screw-cap tubes (C2540), 5 pc 25-place freezer boxes (C2581), 1 pipetting rack (C2590), 1 Decanting rack (C2592), 4 rotor adapters for 15mL cavities (C2570), 20 Caplock clips (C2586)	\$220.00



5mL MacroTubes® Vivid™

- Vivid printed graduations
- Ultra clear polypropylene
- RNase, DNase and Pyrogen free
- Resealable sterile packaging in racks of 50 tubes
- Racks snap apart into two racks of 25

5mL MacroTubes® Vivid™		
Cat. No.	Description	List Price
T2545	5mL Screw-cap MacroTube® Vivid™, sterile, w/vivid printed graduation w/attached screw caps in foam racks, 500/cs	\$119.00



DryChill Ice-free Cooling Blocks

- Utilizes a proprietary gel refrigerant to remain cold (but not freezing)
- Enclosure prevents condensation for a clean work area
- Temperature will maintain 4°C for up to 230 minutes
- As block temperature begins to warm - visual indicator alerts user by changing from purple to pink
- Dimensions 5.9" x 4.2" x 2.8", 2 Year warranty

Cat. No.	Description	List Price
DC9602	DryChill 96 x 0.2mL or 12 PCR Strips, Ice-free Cooling Blocks	\$406.85
DC4020	DryChill 40 x 1.5 - 2.0mL, Ice-free Cooling Blocks	\$406.85
DC1215	DryChill 12 x 15mL, Ice-free Cooling Blocks	\$458.35
DC0650	DryChill 6 x 50mL, Ice-free Cooling Blocks	\$458.35



MultiTherm™ Heating/Cooling Vortexer

- Temperature control from 0° to 100°C
- Precision contoured wells for uniform thermal transfer
- Two models: Heat/Cool or Heat only
- Exchangeable blocks, for tube sizes 0.2mL to 50mL
- Sequence link function for linking or repeating programs (HC model only)

Cat. No.	Description	List Price
H5000-HC	MultiTherm™ Shaker with heating and cooling, 115V	\$3,186.99
H5000-H	MultiTherm™ Shaker with heating only, 115V	\$2,425.62



MultiTherm™ Touch Vortex Mixer

- Large touch screen for simple and easy programming and viewing of status
- Advanced programming features
- Tool-less block exchange
- Optional heated lid

Cat. No.	Description	List Price
H5100-HCT	MultiTherm™ Touch Vortex Mixer, 100-240V with US cord, 115V	\$4,189.14



myTemp™ Mini Digital Incubators (20L)

- Digital temperature control, with in-lab calibration
- Personal sized, 13 x 14.5" footprint
- Two models: Heat only or Heat and Cool

Cat. No.	Description	List Price
H2200-HC	MyTemp™ Mini Digital Incubator, with heating only, 115V	\$ 596.55
H2200-H	MyTemp™ Mini Digital Incubator, with heating and cooling, 115V	\$ 907.43



myTemp™ 65HC Digital Incubator

- Accurate temperature control from 0°C to 60°C
- Stainless steel chamber
- Sized for floor standing use or on bench-tops less than 32" high
- Powerful compressor, maintains 0°C
- Internal power outlet for shakers, mixers, etc.

Cat. No.	Description	List Price
H2265-HC	MyTemp™ 65HC Digital Incubator, with heating and cooling, 115V	\$3,728.40



Incu-Shaker™ Mini Shaking Incubator

- Domed lid accepts flasks up to 1L
- Touch screen control panel
- Extremely compact: just 11" wide
- Exchange flask clamps in one second with MAGic Clamp™ magnetic system

Cat. No.	Description	List Price
H1001-M	Incu-Shaker™ Mini with non-slip rubber mat, 115V	\$ 3,598.96



Incu-Shaker™ Mini CO₂ Shaking Incubator

- Integral orbital shaker, ideal for suspension cell culture
- Six side direct heating, provides uniform temperature
- Stainless steel chamber (SS316), with round corners for easy cleaning
- Dual beam IR sensor, fast response time for precise control over CO₂%

Cat. No.	Description	List Price
H3501	Incu-Shaker™ Mini CO ₂ with non slip rubber mat, 115V	\$11,010.80



Incu-Shaker™ 10L Shaking Incubators

- Two models, heat only or heat/cool
- High capacity, up to 5 x 2L
- Exchange flask clamps in one second with MAGic Clamp™ magnetic system
- Exceptional temperature uniformity
- Optional shelf for Petri dishes, microplates, etc.

Cat. No.	Description	List Price
H2010	Incu-Shaker™ 10L with non-slip rubber mat, 115V	\$ 7,495.31
H2012	Incu-Shaker™ 10LR with non-slip rubber mat, Refrigerated Shaking Incubator, 115V	\$10,596.02



Incu-Shaker™ 20L Stackable Shaking Incubators

- Stackable design for high throughput culturing
- Touch screen control panel
- Stainless steel chamber delivers precise temperature uniformity
- Adjustable shelf

Cat. No.	Description	List Price
H3020	Incu-Shaker 20L with non-slip rubber mat, 115V	\$ 9,995.00
H3022	Incu-Shaker 20LR (Refrigerated) with non-slip rubber mat, 115V	\$12,295.00



Vornado™ Miniature Vortex Mixer

- Powerful vortexing, for tubes up to 50mL
- "Mini" sized, less than 4" wide
- Insta-Touch™ pressure activated operation

Cat. No.	Description	List Price
BV101	Vornado™ Miniature Vortex Mixer, grey cup head, 100 to 240V with US Plug	\$229.09



BenchMixer™ Vortex Mixer

- Powerful motor for INSTANT vortexing
- Variable speed with touch or continuous operation
- Q-Drive™ dynamic balancing system

Cat. No.	Description	List Price
BV1000	BenchMixer™ Vortex Mixer, 115V	\$296.61



myFuge™ Mini Microcentrifuge

- Clik-n-Lok™ instant rotor attachment
- Storage compartment for PCR rotor and 0.5ml adapters
- Includes rotor for 4 PCR strips
- Eight position microtube rotor
- Decelerates in just 1 second

Cat. No.	Description	List Price
C1008-C	MyFuge™ Mini Centrifuge, clear lid, with 2 rotors, 100-240V (US plug)	\$346.90
C1008-B	MyFuge™ Mini Centrifuge, blue lid, with 2 rotors, 100-240V (US plug)	\$346.90
C1008-G	MyFuge™ Mini Centrifuge, green lid, with 2 rotors, 100-240V (US plug)	\$346.90
C1008-P	MyFuge™ Mini Centrifuge, purple lid, with 2 rotors, 100-240V (US plug)	\$346.90
C1008-R	MyFuge™ Mini Centrifuge, red lid, with 2 rotors, 100-240V (US plug)	\$346.90



myFuge™ 12 Microcentrifuge

- COMBI-Rotor™ for tubes and strips
- Near silent operation
- Twice the capacity of most mini centrifuges
- Starts and stops with closing/opening of the lid

Cat. No.	Description	List Price
C1012	myFuge™ 12 Microcentrifuge with Combi-Rotor, 100-240V (US plug)	\$457.47



PlateFuge™ Microplate Centrifuge

- Quickly spins down droplets in PCR plates
- Accepts all popular PCR plates
- Less than half the size of traditional centrifuges
- Unique, patented rotor design prevents sample spillage (skirted, semi and non) and most microtiter plates

Cat. No.	Description	List Price
C2000	PlateFuge™ Microplate Centrifuge with rotor and plate carriers, 115V	\$894.54



Roto-Mini™ Rotating Mixers

- Includes tube holders for common tube sizes
- Available with variable speed control and advanced shaking/mixing modes:
 - Mix (Oscillating) - Pause - Rock
- Also offered with incubation

Cat. No.	Description	List Price
R2020	Roto-Mini™ Rotator with tube holders, 115V	\$441.50
R2024	Roto-Mini™ Plus Variable Speed Rotator with tube holders, 115V	\$530.70

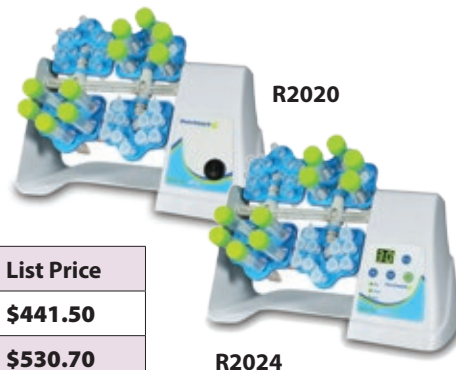

Roto-Therm™ Incubated Rotators

- Rotated mixing with temperature control
- Available with variable speed control and advanced shaking/mixing modes:
 - Mix (oscillating) - Pause - Rock
- Includes tube holders for common tube sizes

Cat. No.	Description	List Price
H2020	Roto-Therm™ Incubated Rotator with tube holders, 115V	\$666.57
H2024	Roto-Therm™ Plus Incubated Rotator (variable speed) with tube holders, 115V	\$889.13







dot scientific inc.

Phone : 800.878.1785
Email : orders@dotscientific.com
Website : www.dotscientific.com
Federal ID# : 38-2757001



Phone : 800.388.0166
Email : info@LPSinc.com
Website : LPSinc.com
Federal ID# : 16-1274974



Phone : 732.757.9764
Email : info@labmart.com
Website : labmart.com
Federal ID# : 87-3691687

